

**WHICH IS THE BEST RIG TO BUY? SEE P. 9!**

JANUARY 1963

50c

**S9**

*the citizens band journal*

COMPLETE FACTS ON  
**NEW PART 19**  
CHANGES!

**CITIZENS BAND**

**MAKE YOUR RIG A P.A. SYSTEM**

**BUILD A "Q MULTIPLIER"**

**BUILD A COAXIAL ANTENNA**

**A SIMPLE TUBE CHECKER**

**BUILD A 2 ELEMENT BEAM**

**8 NEW CB RIGS ANNOUNCED**

**BUILD THE  
"CHANNEL HOPPER"  
CB RIG!**





# NEW!

## INTERNATIONAL

### Model 1500 . . . for the Hobbyist . . .

Now . . . you can be on the air, and operate a two-way radio, without a license. The new International Model 1500 Executive transceiver is certified to fill all FCC Part 15 requirements.

Designed primarily for short range radio communication, you can **talk 1 to 10 miles** with the Model 1500 depending on the height of the antenna/transmitter. What's more there are no restrictions on working skip or sky-wave signals 1,000 miles or more when a band opening occurs. You can also use CW (code) transmission for maximum distance communicating.

The International Model 1500 transceiver is designed to put the maximum RF power into the antenna. This is accomplished by combining the transmitter and antenna into one unit for rooftop mounting, thus eliminating loss through a transmission line.

The exciter unit remains with the receiver. A receiver preamplifier at the antenna boosts weak signals and helps reception. And in addition, the Model 1500 has a field proven supersensitive receiver with a crystal filter to reduce interference from adjacent channel Class D radio units.



# EXECUTIVE TRANSCEIVER

## *No License Required!*

- Certified for FCC Part 15 communication
- 100 milliwatts input / 60 inch antenna
- 27 mc frequency range
- Operates on phone and cw
- Eight channels . . . all crystal controlled
- 115 vac operation
- Quality components and construction

The Model 1500 is a complete package, ready to go on the air. The package includes: ① receiver/driver complete with 8 sets of crystals, ② transmitter/antenna assembly, ③ antenna mount, ④ 5 foot mast, ⑤ 100 feet of control cable, ⑥ microphone, ⑦ key for (CW).

Model 1500 Transceiver complete . . . . . \$299.50\*

See this exciting new transceiver at your International dealer. You can be on the air tomorrow with International's Model 1500.

\*other models from \$80.00

Write for International's complete catalog of radio crystals and equipment.

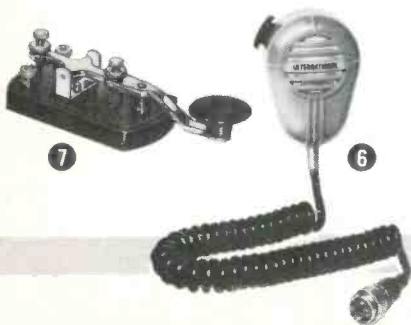

**INTERNATIONAL**  
CRYSTAL MANUFACTURING CO., INC.

18 NORTH LEE • OKLAHOMA CITY, OKLA.



the citizens band journal

Vol. 2, No. 1

January, 1963

S. R. COWAN, PUBLISHER

300 West 43rd Street New York 36, N. Y.

### FEATURES

Finks Unlimited .....	Tom Kneitel, KBG4303	7
Inside poop on the CB spying game!		
What's The Best CB Rig? .....	Herb Friedman, 2W6045	9
An expert's opinion		
Build The CHANNEL HOPPER CB Rig .....	Milt Ogur, 2W5230	14
A cheap and easy AC/DC rig		
Build The N.B.Q.M. ....	Harvey Hurwitz, 2W2921	20
The "No Bucks Q Multiplier"		
For Emergency Use! .....	Jim Gibson, 2W7610	23
Make your rig a P.A. system		
Application for S9 Part 15 Identifier .....		25
Everyone should have one, they're FREE!		
World's Cheapest CB Tube Tester .....	Harold Brown	25
Build it in an hour.		
PHOTO-TOONS! .....	John Comstock	28
Nuttty nonsense for S9'ers!		
8 New CB Rigs This Month! .....		30
These and other new CB products		
Build A Coaxial Vertical Antenna .....	Ed Noll, KCC2618	46
Also a 2 element beam!		
CB in Guatemala .....	Lee Aurick, 2W2870	51
CB South of the border		
FCC PROPOSED RULE CHANGES HIT CB'ERS!!!! .....	Ed Frederick, 2W4580	57
Uncle Sam might swing the axe!		
6 Month S9 Index .....	Staff	61
You asked for it!		

### DEPARTMENTS

Reader Mail .....	4
KBG4303 Rides Again/Tom Kneitel, KBG4303 .....	7
Part 15 Korner/Dean Defton, N-17 .....	25
On The Counters .....	30
Antennas/Ed Noll, KCC2618 .....	46
Test Gear/Herb Friedman, 2W6045 .....	49
CB Answerman/Len Buckwalter, KBA4480 .....	44
CB Casebook/Lee Aurick, 2W2870 .....	51
Electronics 'n Stuff/Don Stoner, 11W1507 .....	53
CB Club Notes/John Krejc, 2W4586 .....	55
Washington Outlook/Ed Frederick, 2W4580 .....	57

### STAFF

<i>editor</i>	<b>Tom Kneitel, KBG4303</b>
<i>associate editor</i>	<b>Don Stoner, 11W1507</b>
<i>contributing editor</i>	<b>Lee Aurick, 2W2870</b>
<i>contributing editor</i>	<b>Ed Noll, KCC2618</b>
<i>contributing editor</i>	<b>Harvey Hurwitz, 2W2921</b>
<i>contributing editor</i>	<b>Edwin Frederick, 2W4580</b>
<i>contributing editor</i>	<b>Paul Arnovitz, XM52127</b>
<i>contributing editor</i>	<b>John Krejc, 2W4586</b>
<i>advertising representative</i>	<b>Dick Cowan</b>
<i>advertising representative</i>	<b>Jack Schneider, 2W5669</b>
<i>circulation manager</i>	<b>Hal Weisner, KBG4528</b>
<i>production manager</i>	<b>Cary L. Cowan, KBG4036</b>
<i>asst. prod. manager</i>	<b>Sol Nussbaum, KBG4903</b>
<i>publication consultant</i>	<b>David Saltman</b>

S9 (title registered U.S. Post Office) is published monthly by Cowan Publishing Corp. Executive, editorial and advertising offices at 300 West 43rd Street, New York 36, N. Y. Telephone JU 2-4460.

Subscription Rates: One year \$5.00, two years \$9.00, three years \$13.00 in United States and Possessions, APO, FPO, and Canada.

Printed in U.S.A. Entire contents copyright 1963 by Cowan Publishing Corp. S9 does not assume responsibility for unsolicited manuscripts. We regard all material sent to us in CB club publications as being intended for publication in S9 as a public relations gesture of the club. We cannot pay for the use of this public relations material, although we do pay for editorial material which is specifically written for us and accepted for publication.

Controlled Circulation Postage Paid at New York, N. Y.



FOR POWER OR PORTABILITY . . . UNCOMPROMISING ENGINEERING WITH

# EICO® CITIZENS BAND TRANSCEIVERS



Operates 2500 hours on 1 rechargeable leakproof battery.

**EICO WALKIE-TALKIE MODEL 740: Kit \$54.95. Wired \$79.95.**

Carrying Case \$3.95.

Complete with rechargeable battery & charger. No license or permit needed . . . no age limit

**U. S.-made  
an original  
product of EICO  
research**

Size: 7 1/8" x 2 5/8" x 1 5/8", weighs only 19 oz. . . . fits comfortably in hand, slips easily in jacket pocket.

• Finest U. S.-made nickel-cadmium rechargeable battery provides about 8 hours "on" time with 50% duty-cycle operation on a single charge • Battery can be recharged 300 times, replacing over 1,000 penlight cells (over \$200.00 worth) • Leakproof nickel-cadmium battery is hermetically sealed in plastic — can never cause corrosion damage • Full 100mW input to Final, as permitted by FCC for **Unlicensed Citizens Band Operation** • Crystal-controlled transmit & receive • Full modern superhet receiver • 9 transistors and 1 diode • Range 1 1/2 miles under average conditions • High quality circuit board, beginner-tested instructions for complete kitbuilding ease and assurance • Make a "network" with 2 or more EICO #740's or with EICO 770 series.

## NEW VERSATILITY WITH NEW DELUXE 770 SERIES

	Kit	Wired
Model 770: 117 VAC only	\$79.95	\$109.95
Model 771: 117 VAC and 6 VDC*	89.95	119.95
Model 772: 117 VAC and 12 VDC*	89.95	119.95

\*Including Posi-Lock Mounting Bracket (U.S. Pat.)

"A steal . . . Better than manufacturing specs . . . Base to mobile contact out to 22 miles consistently, often to 40 miles . . . Thorough manual is almost a handbook for CB radio."—Tom Kneitel, Editor, S9 MAGAZINE

Front panel selection of one of 3 transmit crystals with continuous receiver tuning over all 23 CB channels, or a fourth transmit crystal with appropriate receiving crystal. Press-to-talk button on microphone; transmit-receive switching accomplished by high-quality relay with minimum capacity between contacts to prevent current leakage at RF frequencies. Superhet receiver with RF stage for high sensitivity & proper signal-to-noise ratio. 1750 KC IF strip for unequalled image rejection & freedom from oscillator "pulling" on strong signals. IF strip realigned so that only "touchup" alignment without instruments is needed. Current metering jack in series in cathode circuit allows checking of input power to transmitter final and adjusting it to FCC limit. 13-tube performance (4 dual function tubes, 4 single function tubes, plus germanium diode). Adjustable squelch control (in addition to automatic noise limiter). Optimum adjustment to any popular CB antenna assured through use of variable pi network in output. AVC. 3" x 5" oval PM speaker. Supplied complete with 8 tubes & 1 transmit crystal (extra crystals \$3.95 each).



U.S. Pat.

The entire transmitter oscillator circuit and RF final in every EICO transceiver, kit and wired, is pre-mounted prewired, retuned, and sealed at the factory (about 3 hours of skilled labor, precision adjustments and testing), complying with FCC regulations (section 19.71, part d). This permits you to build the kit and put it on the air without the supervision of a commercial radio-telephone licensee.

## BEST BUYS IN STEREO/MONO HI-FI: everything from Tape Decks to Speakers

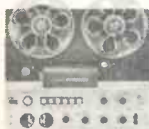

Transistorized Stereo/Mono 4-Track Tape-Deck RP100 Semi Kit (electronics in kit form) \$299.95 Wired \$399.95



FM-AM Stereo Tuner ST96 Kit \$89.95\* Wired \$129.95\* \*Incl. FET

New Stereo FM Multiplex Tuner ST97 Kit \$99.95\* Wired \$149.95\*



40 Watt Integrated Stereo Amplifier ST40 Kit \$79.95 Wired \$129.95

70-Watt Integrated Stereo Amplifier ST70 Kit \$99.95 Wired \$149.95

## BEST BUYS IN SERVICE INSTRUMENTS: everything from Scopes to Probes



DC-5 MC 5" Scope #460. Kit \$79.95 Wired \$129.50. Also available—General Purpose 5" Scope #427 Kit \$69.95 Wired \$109.95

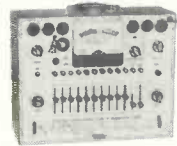

Dynamic Conductance Tube & Transistor Tester #666 Kit \$69.95 Wired \$109.95 Complete with steel cover & handle

EICO 3300 N. Blvd., I. C. 1, N. Y. S9,  
 Send Free 32-page Catalog & Distributor's name.  
 Send Free Schematic of Model No. \_\_\_\_\_  
 Send new 36-page GUIDEBOOK TO HI-FI for which I enclose 25¢ for postage & handling.

Peak-To-Peak VTVM #232 & †Uni-Probe®. Kit \$29.95 Wired \$49.95 VTVM #221 Kit \$25.95 Wired \$39.95



U. S. Pat.

TV-FM Sweep Generator & Marker #368 Kit \$69.95 Wired \$119.95



Name \_\_\_\_\_  
Address \_\_\_\_\_  
City \_\_\_\_\_ Zone \_\_\_\_\_ State \_\_\_\_\_

Export Dept., Rouborn Agencies Inc.  
431 Greenwich St., New York 13, N. Y.

EICO ELECTRONIC INSTRUMENT CO., INC., 3300 NORTHERN BLVD., LONG ISLAND CITY 1, N. Y.

Write to our advertisers for special product news

January 1963 • S9 • 3

# READER MAIL

## CALLBOOK FEEDBACK

Editor:

Perhaps you can give me some guidance regarding CB callbooks. Last year several of my friends and I received copies of the "Q" book with whole sections missing. I now hear that CB'ers all over the country had the same thing happen. This burns me up. Will there be callbooks this year. and. if so, will this same thing happen again? I don't want to get stuck twice!

Karl Lyon, 2A4671  
Montclair, N. J.

*Sorry Karl, S9 has never published a callbook so I'm afraid that we can't apologize for what seems to be a poor-quality job. Also, we can't give you any predictions on what's ahead for CB callbooks, although, off hand, it would certainly seem that with pending FCC regulations (see this month's WASHINGTON OUTLOOK column) it would be a most foolhardy venture (commercially) to bring out a publication catering to what might possibly be a vanishing species, the CB DX enthusiast. Unlike automobiles, which were intended for business and pleasure use, Part 19 CB was established for business and personal (not "pleasure") communications. It is popularly believed among "insiders" that callbooks for Part 19 CB'ers have now been turned into instruments for encouraging the improper use of the band, a direct cause for the current FCC proposals to tighten up on Part 19. No, we won't be publishing any Part 19 callbooks.*

## STRONG WORDS

Editor:

Please make S9 order forms (in the back of the book) so that they can be removed without causing total destruction of the issue, or the course of Yona Schimmel be upon you!

By the way, what are the chances for Gridley Snarfwort's parole?

William Cooper, KDH2002  
Miami Beach, Fla.

*The idea, Bill, is to separate the envelope from the binding by gently ripping along the perforation. Lay-off the Wheaties and spinach for a few days and try again.*

*If you knew what a miserable guy this Snarfwort was you wouldn't be so anxious to get him out of the clink.*

## EXPENSIVE EXPANSION

Editor:

Your article on test gear in the November, 1962, issue kept me from making an expensive mistake. Thanks a heap!

Dennis Gibbs, 19Q4647  
Wyandotte, Mich.

## DON'T BE FOOLED!

Editor:

As a rather enthusiastic CB buff, I find S9 most interesting and helpful in my pursuit of better 11 meter operation.

It isn't hard to identify S9 at my local CB shop—your modern covers with the bold red and black "S9" on a white background are sure eye-catchers. But, and this might be of interest to you, I almost made the mistake of buying what I consider to be an inferior publication this month, because it looks to me like the "other guys" have now begun copying your cover style in great detail. Fortunately, that's where the similarity ends. I'm an S9'er, and I positively refuse to settle for anything less anymore. Keep up the great work!

Ben Kimball  
Glendora, Calif.

*"Imitated, but NEVER duplicated" is our motto at S9, Ben. We are aware of the situation which you mention, as it has been called to our attention by other S9'ers. All we can do about it is grin and bear it, and chuckle as we repeat that tried and true adage, "imitation is the sincerest form of flattery!" We're happy that you dig S9 because we put a lot of work into it to keep it up to the level today's readers demand.*

*It will interest you to know that S9 is now the only, repeat only, publication for CB'ers to have an extensive nationwide reporting staff—yup, John Krejc, our CB Club and Activities Editor, is presently receiving information from more than 500 special S9 field reporters.*

*While others wildly plead for readers to "rally 'round the flag" and must resort to hawking all manner of cut-rate, bargain basement subscription deals to attract readers, we at S9 feel that the only one thing which will attract and keep readers is a quality publication, professionally written, and published on a national basis. Our regular editorial and feature-writing staff contains the "cream of the crop" of CB authors because we wouldn't dare ask our thousands of subscribers and newsstand readers to accept less than this.*

## THE PHANTOM STRIKES

Editor:

At a recent CB gathering, a member of the club stated that his group was handing out citations in cooperation with the FCC. Another member of the same group stated that a 20-hour monitoring and taping vigil is also maintained.

Just when did the FCC start this neighbor spying practice?

Theodore Wanatowicz, KBA3193  
Torrington, Conn.

*Ted, see our editorial this month on page 7.*

*Watch for next month's big issue*

# The new RCA MARK VIII 27-Mc 2-WAY RADIO



## More Features • Improved Performance • AT A LOWER PRICE

Here is THE outstanding bargain today in a 2-way Citizens' Band radio: THE NEW RCA MARK VIII. Compact, dependable, simple to operate, it outperforms and offers more features than even the famous RCA Mark VII.

Look what this remarkable new unit offers you:

- 9 crystal-controlled transmit and receive channels
- Tunable receiver for reception of 23 C-B channels; dial marked in both channel numbers and frequency
- Exceptionally good voice reproduction—high intelligibility
- Maximum allowable transmitter input of 5 watts\*—nominal output of 3 watts or more
- Highly selective superheterodyne receiver with one rf and two if amplifier stages
- Operates from standard 117-volt AC; separate DC power supply (optional) for mobile installations (you don't pay for unnecessary power supplies)
- Electronic switching—no relay noise or chatter
- Illuminated "working channel" feature
- Light and compact—only 3½ inches high, weighs only 8 pounds with mike; fits easily under the dashboard of even a compact car
- Improved Automatic Noise Limiter to reduce effects of ignition and similar interference

plus many more features to increase its usefulness and efficiency.

The new low Mark VIII price **\$149<sup>50</sup>\*\***  
puts 2-way radio convenience within reach of everyone

GET THE FULL STORY; FILL OUT AND SEND IN THE COUPON BELOW

RCA Electron Tube Division, Commercial Engineering, Dept. A132-R  
415 South Fifth Street, Harrison, New Jersey

Please! Rush more information on the new RCA Mark VIII 2-way  
Citizens' Band Radio.

Name \_\_\_\_\_  
Address \_\_\_\_\_  
City \_\_\_\_\_ Zone \_\_\_\_\_ State \_\_\_\_\_

\*Maximum plate input power to final radio-frequency  
amplifier stages as defined by FCC regulations

\*\*Optional list price



The Most Trusted Name in Electronics

Special club subscription rates for \$9

January 1963 • S9 • 5



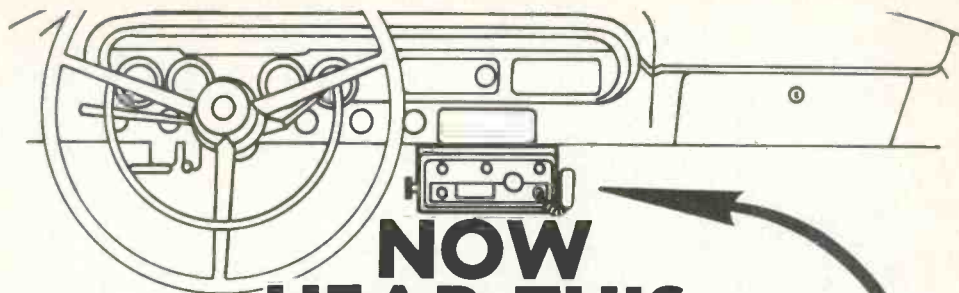

# NOW HEAR THIS:



## ... Browning Brings You 23-Channel Operation In A Mobile CB Unit.

Now, you can own a mighty mobile rig that lets you operate on any of 23 channels at the flick of a channel selector switch.

Model M-523 is designed and manufactured by Browning to give you big base station performance in a mobile unit. Ideal for car, boat, or other vehicles, Model M-523 has a transistorized DC power supply that can be mounted in any location, plus many other Browning features.

This compact powerhouse (8" x 3" x 9" deep) is easy to mount and leaves plenty of leg room. Contact your local authorized service center or write for information. Also available is Browning Model M-506, mobile transceiver for 6-channel operation.

### OVERALL FEATURES

- Small size (8" x 3" x 9" deep) makes for easy mounting and more knee room.
- Rear lighted channel indicator.
- Transmit and receive channel selected simultaneously with flick of channel selector switch.
- Modern styling matches interior of all cars and boats.
- Price includes 12-volt power supply, speaker and microphone.
- Transistorized DC power supply providing high efficiency and reduced maintenance can be mounted in any location.

### TRANSMITTER SPECIFICATIONS

- Plate power input: 5 watts.
- Power output to antenna: 3.5 watts.
- Modulation — 100%, peak limited, plate modulation.
- Harmonic suppression: Better than 50 db down through use of TVI Trap.
- Frequency stability: .005% per FCC specifications.

### RECEIVER SPECIFICATIONS

- Sensitivity: 0.4 UV for 10 db signal to noise ratio.
- Selectivity: 5 KC @ 6 db; adjacent channel 60 db down.
- Frequency stability: .005%.

### ACCESSORIES

- AC power supply — Model AC-115.
- S-Meter with illuminated dial — Model DB-40.
- Rear deck speaker kit — Model SK-1.

Browning Service Center Franchises Available—  
Mail Coupon →

Send for new 16-page Browning CB Catalog. For free copy, write Dept. 59 100 Union Avenue, Laconia, New Hampshire.



Browning Labs, Inc.  
100 Union Ave., Laconia, N. H.

Please send me full information about operating a Franchised Browning Service Center.

Name .....  
Address .....  
Call Letters .....  
City ..... State .....  
Other lines handled .....



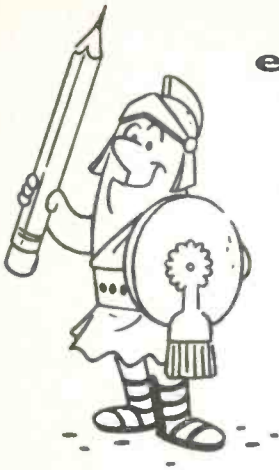

editorial

# KBG4303 rides again!

by TOM KNEITEL

EDITOR, S9  
300 WEST 43rd STREET  
NEW YORK 36, N. Y.

## FINKS UNLIMITED

In a number of the metropolitan areas, where CB activity is normally high, there are many "Snitch Clubs" (also known as "Sneak Clubs," "Fink Clubs" or "Rat Clubs") in operation. The avowed purpose of these outfits is to "clean up the band." This is supposedly accomplished by sending CB'ers warning cards or notices advising of alleged improper operations on 27 mc/s. So the story usually goes, the local FCC office receives duplicate copies of these notices and if three such notices are issued to a CB'er, the FCC takes action against the supposedly errant operator.

This is some more whoop-de-doo from the fairy tale factory.

Perhaps we can examine the various aspects of the above and see the situation in its true light.

1. Section 605 of The Communications Act of 1934, as amended, prohibits a CB'er from referring to the contents of transmissions of another CB'er, *or even referring to the fact that any transmissions even existed in the first place* without the express permission of the CB'er who made the transmission. To do so would invade the privacy of the CB'er and impinge on his legal right to the secrecy of his communications. In the eyes of the law this is the same as if one CB'er had tapped the telephone of the other.

2. The FCC rules will permit members of specific clubs to perform monitoring duties, however, they may monitor only other members of the club who have specifically requested to participate in a program of having their transmissions monitored for such purposes. This does not imply any FCC endorse-

ment of the club or the persons doing the monitoring.

3. The FCC does *not* take official action against a CB'er when it has as its *only* guide 3 (or 3,000) privately issued "monitoring violation notices." The station would have had to have been monitored by a regular FCC operated monitoring station.

4. A CB'er who receives a non-FCC monitoring notice against his wishes could file a complaint with the U.S. Department of Justice against the person or persons who sent the notice. The government could ultimately take action against the senders under the antiwiretapping laws. Maximum penalties could bring a \$10,000 fine, 1 year in jail, *or both* (Section 501 of the Communications Act of 1934, as amended).

5. It is *not* reasonable to assume that, even under a so-called "authorized" intra-club monitoring program, the persons performing the monitoring could be doing any more than giving their personal opinion as to whether, and to what extent, a CB'er was operating improperly. The FCC rules regarding CB operation leave a lot to interpretation and the imagination and, in some instances, even FCC people in different areas have given conflicting interpretations of specific sections of Part 19.

Regardless of the foregoing, the self-appointed *Junior G Men* continue to issue forth a barrage of these worthless, but official-looking, notices. As is usually the case, to avoid Federal prosecution, they hide behind a cloak of anonymity by signing neither their names nor callsigns.

*Continued on page 58*

# LAFAYETTE CB

## Spectacular

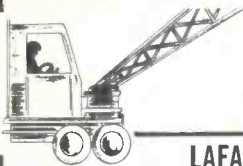

**New!**

LAFAYETTE 10-TRANSISTOR  
PORTABLE CITIZENS BAND  
"WALKIE TALKIE"

**33.95 ea 2-for-62.90**



HE-29B

- 50% More Powerful — Receives and Transmits Up to 2 Miles
- Extra RF Stage
- 10 Transistors plus 1 Diode
- No Licenses, Tests or Age Limits (As per FCC Regulation 15)
- With Carrying Case, Earphone, Antenna, Batteries, Crystals

**New!**

LAFAYETTE HE-20C CITIZENS  
BAND TRANSCEIVER

Officially Approved  
for Use in  
CANADA  
Type Approval  
No. 169361029

**109.50**



HE-20C

- 8 Crystal Controlled Transmit Positions plus 8 Crystal Controlled Receive Positions
- 14 Tube Performance
- Tuneable over all 23 Channels
- Built-in Power Supply for 110V AC or 12V DC
- Complete with Matched Crystals for Channel 9

**New!**

LAFAYETTE HE-15B  
CITIZENS BAND  
TRANSCEIVER

Officially Approved  
for Use in  
CANADA  
Type Approval  
No. 169361034

**54.50**



HE-15

- 8 Crystal-Controlled Transmitting Positions
- Tunable Superhet Receiver Over All 23 Channels
- Effective Full-Wave Variable Noise Limiter
- Front Panel RF Jack • 12 Tube Performance
- With Transmitting Crystal for Channel 9

**New!**

LAFAYETTE 4-TRANSISTOR  
CITIZENS BAND  
"WALKIE TALKIE"

**19.95 ea**  
2 for 38.95



HE-66

- Sensitive Superheterodyne Circuit
- Crystal-Controlled Receive and Transmit
- Push-to-Talk Switch
- No License Required When Used Under Art. 15 FCC Regulations.

## LAFAYETTE RADIO ELECTRONICS

SYOSSET, N. Y.  
JAMAICA, N. Y.

NEW YORK, N. Y.  
BRONX, N. Y.

SCARSDALE, N. Y.  
PLAINFIELD, N. J.

PARAMUS, N. J.  
NEWARK, N. J.

BOSTON, MASS.  
NATICK, MASS.

**Free!**

MAIL THE  
COUPON FOR  
YOUR FREE  
1963 LAFAYETTE  
CATALOG

LAFAYETTE RADIO ELECTRONICS DEPT. S9A-3  
P.O. Box 10, Syosset, L. I., N. Y.

\$ \_\_\_\_\_ enclosed for Stock No. \_\_\_\_\_  
shipping charges collect.

Send me the  
Free 1963 388-  
Page Lafayette  
Catalog

Name \_\_\_\_\_

Address \_\_\_\_\_

City \_\_\_\_\_

Zone \_\_\_\_\_ State \_\_\_\_\_

# WHAT'S "THE BEST" CB RIG?

## THE \$64,000 QUESTION ON THE BAND

by HERB FRIEDMAN, 2W6045

The past several months have given a pretty good indication of the direction in which CB will be heading during 1963 — equipment-wise, that is. More and more manufacturers are concentrating on super-deluxe transceivers and even deluxe modular (that is, component) stations. Yes, the time has finally come to CB, as in all good things, that there are enough people clamoring for products that manufacturers are trying to out-do each other to give the public "THE BEST," or at least their own version of "THE BEST."

The funny thing of it all is that no two manufacturers can seem to agree on what actually is "THE BEST." Some units dangle in front of our eyes a proliferation of meters (percent modulation, SWR, power output, signal strength, etc., etc.), others concentrate on extraordinary selectivity, highest-quality components, others appeal to the little woman with decorator styling. Some rigs are aimed at the commercial user, some at the personal user, and many at both.

We've been keeping our ear to the ground and our eye to the crystal ball to see what features are currently available, what features *will* be available, and what CB'ers can expect to see "standardized" into future deluxe equipment.

### RECEIVERS

First on our receiver list is *selectivity*. In terms of circuits, selectivity will probably standardize on *the equivalent* of two stages of 455 kc/s IF. How it will be done, of course, will be up to the individual engineering de-







Tried and true, The International Crystal EXECUTIVE 100 shown with the EXECUTIVE model 23-channel frequency synthesizer. The EXEC 100 contains a number of deluxe features, with the dual conversion plus-crystal-filter receiver being especially good. A speech clipper accessory is also available.



The new look of the e.c.i. COURIER 1-M. The rig features triple conversion in the receiver, among other goodies.

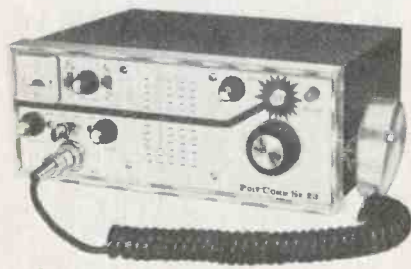

The Polycomm Sr. 23 has a multitude of deluxe features, including built-in selective calling and a 23 channel crystal synthesizer.

partments at each manufacturer. Since double conversion IF strips will be employed in most units, this will probably be accomplished through the use of low-plus-high frequency IF's in conjunction with crystal, ceramic or mechanical filters, or maybe by *very* low frequency IF's (262 kc/s, 100 kc/s, or even as low as 85 kc/s) in conjunction with high frequency IF's (4.5 mc/s, 10 mc/s, etc.). An exotic variation of this is a high IF, into a low IF, *plus* a crystal or mechanical filter (this is already available).

While low cost rigs will always be popular and serve their very necessary purposes to CB'ers, shoppers for deluxe units should carefully study the unit they are considering to see exactly what type of selectivity they will wind up with. After all, selectivity is one of the factors which determines the utility (and price) of the equipment.

### THE FRONT END

Front ends will probably use Nuvistors. We go with Nuvistors because the popularity of these little devices has reached a frantic pitch with CB'ers—what you might even call "the latest fad." As a matter of fact there *are* tubes which will give better front end performance than Nuvistors, but the rugged, inexpensive, and *new* Nuvistor will triumph in the end because of the fact that the public wants them (to say nothing of the fact that they really do a pretty good job).

### AUDIO

While, to our knowledge, only one manufacturer is presently using the circuit, *receiver* audio compression will probably become a CB standard. Receiver compression is similar to, but does not have to have the distortion-free characteristics of transmitter compression—it is therefore an easy to add "extra." Receiver compression prevents local signals from blasting-in when the volume is cranked wide-open to receive a weak signal. The compression establishes a *ceiling* on the volume at a comfortable listening level and any signal caught trying to wander above this level is promptly "crushed" down to the *ceiling*. Even if the volume control is fully advanced, the speaker volume is held (approximately) to the *ceiling*. Naturally, an on-off switch is provided to cut this feature in and out of the circuit. AVC systems are in line for improvement to prevent receiver blocking by strong locals.

## NOISE LIMITING?

Unquestionably, receivers will be tunable over all twenty-three channels with provisions for some fixed-tune channels. We say fixed-tune rather than crystal control because fixed-tune circuits are more flexible—they can be changed when you want, without the need to wait for new crystals. Although voltage regulated receive oscillators will insure accurate dial calibration modulated channel spotters will be included since they assist, to some degree, in keeping the receiver in good alignment. They are also a convenience if component aging changes the dial calibration and you don't care to realign.

Noise limiters are due for a substantial improvement. Where cost is not a limiting factor, so-called "IF silencers" should start to make the CB scene. Some units, to keep the initial cost down, may make provisions for add-on silencers. Or, some modern limiter, such as the "opposite end" type will be used. However it's done, you can look forward to some comfortable mobile receiving.

## TRANSMITTERS

Transmitters will see a major improvement in the modulator. Speech compression and ("clipping," or "limiting") will most likely be standard circuits in the deluxe transceivers. While compression circuits will no doubt be more advantageous as far as easy copy through interference is concerned, clippers will probably be popular for the reason that their inherent distortion gives (those CB'ers who *don't* need the clipping) the effect of modifying the audio—which is at least *something* happening! Many "modification crazed" CB'ers loose sight of the fact that modifications existing circuits, while helpful to *one* particular CB'er, may be of *no* value to others.

Clippers will establish a 100% modulation ceiling and the modulators can be designed for maximum modulation on any voice rather than just being averaged. With either circuit, compression or clipping, the CB'er will readily accept the modified modulation when he goes to the counter of his favorite CB shop.

## METERING

As far as metering is concerned, only two meters are really *needed*—the "S-meter" and the power *output* meter. The output meter samples the transmitter's output into the transmission line, so when the meter reads

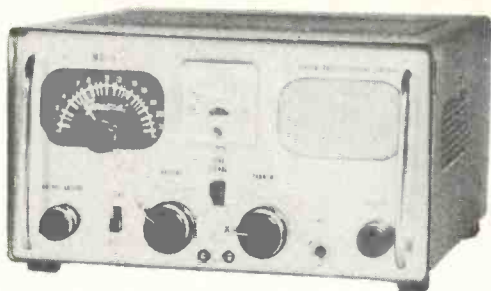

The General Radiotelephone MC-5, a deluxe unit in itself, is now the world's first CB single sideband rig when coupled with General's new SSB adapter.



Browning Labs' deluxe base station consists of their R-2700A super receiver and their "23-S NINE" transmitter companion unit.



The Webster BAND SPANNER 440 combines nifty electronic design with one of the best looking exteriors available.



Tram's deluxe TR-70 base station features superior engineering and an extremely sensitive receiver.

maximum the CB'er will know that he is peaked for maximum operation capabilities. The inclusion of the output meter makes the CB station self-contained and it can be set up anywhere without the need of accessory output indicators.

Modulation *indicators*, rather than meters, will probably find popularity in the forthcoming deluxe rigs. For greatest accuracy, a "peak modulation" light will be used on many rigs.

### MISCELLEANY

There has been considerable interest in low-pass TVI filters being installed in CB rigs. Actually, CB rigs will seldom fully "block" a TV set because of the low power output of a CB rig—however TVI due to harmonic radiation is generally the cause of most of the CB'ers TVI problems. Because high-attenuation low-pass filters have been found to water-down much of the TVI from CB stations, deluxe rigs will most likely contain such devices.

Frequency synthesizers are already making interesting inroads into the CB market, both as modular units, or built into the transceiver itself. We predict that they will rapidly pick-up in popularity in coming months.

Selective calling has already earned itself a niche in the CB scene, and with the channels becoming more and more crowded it is not unreasonable to assume that many persons who had at first pegged selective calling as something strictly for the commercial CB user, will realize that this is possibly the best answer to living with a crowded band, even for personal users. One set already has selective calling built-in, more will follow.

Single Sideband (SSB) is already a reality as an accessory, as just announced by General Radiotelephone. Presumably, SSB will be included in the circuitry of some CB sets now on the drawing boards. At any rate, SSB will be a boon to the industrial and commercial users of CB and it's a welcome deluxe addition.

We further predict that Part 15 (100 mw) base station units will start popping onto the market to satisfy hobby enthusiasts on 11 meters who can operate in this manner under the easy-going Part 15 rules. These sets will, in their own right, be deluxe units with many of the features found in the regular Class D stations and selling at similar prices.

Certainly, International's new EXECUTIVE 1500 Part 15 base station meets the requirements of a deluxe station in every sense of the meaning.

### IN SUMMARY

Depending upon the manufacturer, other improved circuits will be used. While flashing lamps, neon signs, chimes, whistles, and other paraphernalia do not necessarily improve a CB signal, we are certain that some sets will have even these if it is discovered that this is what the market is asking for.

We have given you the circuits of major importance and interest; of course deluxe transceivers having *all* of the best features would be very high priced—but when you consider that many deluxe base stations command a price tag in the vicinity of \$350 to \$400, you are entitled to expect "THE BEST."

**INCREASE AUDIO**  
**100%**

**GLOBE  
POWER  
TALK  
VOICE  
BOOSTER**



Peak limiting audio preamplifier that clips and filters speech frequencies and levels exceeding preset amplitude. Increases modulation intensity for most efficient audio. Includes audio harmonic suppression. Adaptable to any Transceiver or transmitter.

**Model 65-419 Voice Booster . . . . . CB Net 24.95**  
*Completely assembled at your distributors now.*

FREE CATALOG of the entire Globe CB line. Send to GLOBE dept. 27, 400 So. Wyman St., Rockford, Ill. USA

Name \_\_\_\_\_  
Address \_\_\_\_\_  
City \_\_\_\_\_ State \_\_\_\_\_



**GC ELECTRONICS CO.** DIVISION OF TETRON ELECTRONICS, INC.  
ROCKFORD, ILL. U.S.A.





# CB PHONE

E  
T  
I  
Q  
U  
E  
T  
T  
E

“Juliett does the Foxtrot and Tango with Romeo at the Hotel Lima in Quebec while her Yankee Papa Echoes his plea that Whiskey and Golf won’t win her an Oscar in India.”

If these names don’t sound familiar, you’re dating yourself. They are part of the new international phonetic alphabet. Zebra, Love, Queen and the ubiquitous Roger are victims of international cooperation.

The “old” alphabet contained sounds that were not understandable in all languages. Virtually every word of the old phonetic alphabet used syllables that could not be pronounced by seamen or airmen from some nation so

the linguists of the world—including the Russians—met, compromised and finally agreed on an entirely new set of sounds for the old familiar words that used to crackle over the airwaves.

You will find that your CB communications will be greatly improved when you use these easy-to-understand phonetics to spell out words over the air.

A	Alfa	AL-fah
B	Bravo	BRAH-voh
C	Charlie	CHAR-lee (or SHAR-lee)
D	Delta	DELL-tah
E	Echo	ECK-oh
F	Foxtrot	FOKS-trot
G	Golr	GOLF
H	Hotel	HOH-tel
I	India	IN-dee-ah
J	Juliett	JEW-lee-ett
K	Kilo	KEY-loh
L	Lima	LEE-mah
M	Mike	MIKE
N	November	No- <b>VEM</b> -ber
O	Oscar	OSS-cah
P	Papa	Pah-PAH
Q	Quebec	Keh-BECK
R	Romeo	ROW-me-oh
S	Sierra	See-AIR-rah
T	Tango	TANG-go
U	Uniform	YOU-nee-form (or OO-nee-form)
V	Victor	VIK-tah
W	Whiskey	WISS-key
X	X-ray	ECKS-ray
Y	Yankee	YANK-Key
Z	Zulu	ZOO-loo



# Build The CHANNEL HOPPER

## A SIMPLE AND INEXPENSIVE AC/DC CB RIG

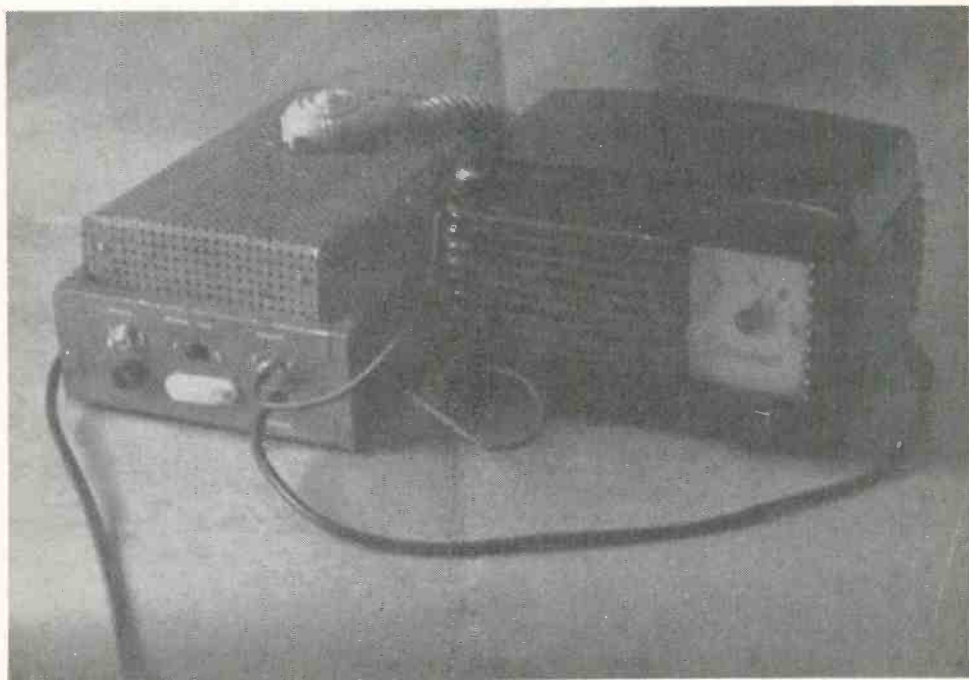

by MILTON OGUR, 2W5230

Here at last is the CB rig you've been waiting for—an AC/DC unit that is easy and inexpensive to construct; simple and safe to operate. It utilizes a commercially available printed circuit board for the converter, and the transmitter may be point-to-point wired or constructed from a PC board. The converter feeds the antenna circuit of any broadcast receiver. The "Channel Hopper" is so light that it may be easily transported in a small satchel. The unit can be built with about \$40 worth of parts and the spare time found during a normal week.

A study of the schematic drawing (Fig. 1), shows this transmitter to be a crystal-controlled MOPA unit, utilizing just one triode of a 12AU7 tube for the oscillator stage. The commercial coil used for the plate tank was found to resonate at the desired frequency with none but the inherent distri-

buted capacity values of the circuit. The output of the oscillator is coupled to the grid of the power output stage—a 50C5 pentode—by means of C2. The RF output of the 50C5 in turn is coupled by means of C4 to a chassis-mounted pi network and to the antenna loading it, via S2 and J2.

Plate modulation of the power output stage is achieved via T2 (a universal type audio output transformer), and a single audio stage (likewise a 50C5). A single button carbon microphone, deriving its voltage from the modulator cathode, is activated by a local press-to-talk switch which does not, however, switch the carrier or receiver. T1, chosen to give a high voltage buildup, couples the mike audio to the modulator grid. The transmitter PC board is available in limited quantities from the source shown in the parts list.

The power supply, controlled by S1, is a fuse-protected AC-DC type, and feeds AC

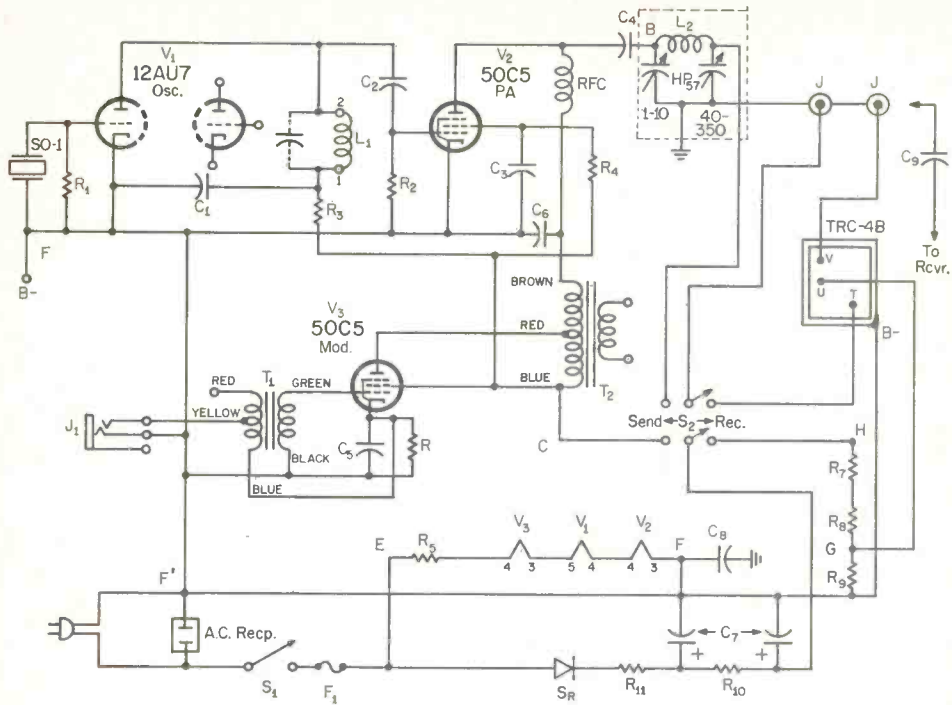

Fig. 1. Schematic diagram of the CHANNEL HOPPER CB rig.

line voltage to the 3 tube filaments (using the 12.6 volt, 150 ma. connection on the 12AU7), in series with a 33 ohm, 2 watt dropping resistor, R5. This string is returned to the B- bus on the converter board, is isolated from the chassis by means of C8 to eliminate shock hazard. To develop 150 volts B+, AC line voltage is rectified by a single silicon diode and filtered by a pi network consisting of R10 and C7. The output of this filter is adequate to provide close to 5 watts input to the final power amplifier and to energize voltage divider R7, 8 and 9, from which the 12 volt power necessary for the converter is derived. This power is also returned to B-.

The TRC-4B converter, a commercially available printed circuit board, is a transistorized, 3-stage superheterodyne unit which converts signals in the 11 meter band to the broadcast band, feeding its output via J3, connecting cable, and C9 to the input of any broadcast receiver.

Dual switching is done by S2 which connects the CB antenna to the input of the converter on *Receive*, or the output of the transmitter on *Send* or *Transmit*; it also controls transmitter power and converter power

by connecting 150 V.DC alternately to Pt. C on *Send* or to the voltage divider on *Receive*.

### CONSTRUCTION

The entire "Channel Hopper" can be mounted in an inverted aluminum chassis, 8" x 12" x 3". The layout shown in Fig. 2 is recommended. If you plan to paint the chassis, do it right after the drilling is finished, and before any components are mounted, to save yourself a masking problem later on. While waiting for the spray enamel to dry, you can save time by preparing both printed circuit boards.

Whether you build the transmitter section with point-to-point wiring on a "Vector Board" or use the PC Board version, you must mount and solder all components. Drill mounting holes for 6-32 bolts at the 8 spots marked with circles. This includes 4 board mounts and 4 transformer holes. Also drill holes for each component or connecting lead, wherever indicated, with smallest size drill possible. Mount both transformers on the foil side bottom of the board, paying careful attention to the proper orientation of the col-



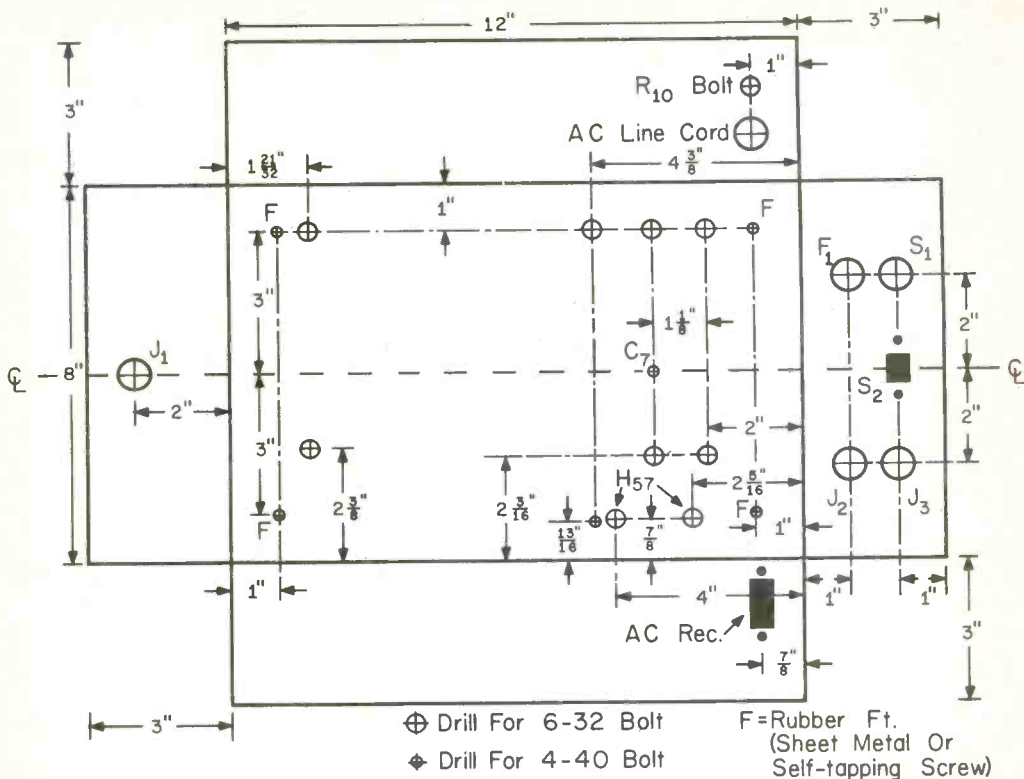

Fig. 2. Chassis layout of the CHANNEL HOPPER.

ored leads. Be equally careful when orienting and mounting the 3 tube sockets, the crystal socket, and L1, also on the underside of the board. Tube sockets need not be bolted to the board; soldering the terminals to the proper conductors will suffice. After soldering L1 in place, glue the bottom rim of the coil form to the board with epoxy cement. On the top side of the board, mount all resistors and capacitors indicating by pushing leads through appropriate holes and bending them over to hold them in place until soldered, after which they can be trimmed. This applies also to the jumpers, wherever these are indicated. Leave chassis lead of C8 *not* connected.

The TRC-4B comes with a pre-drilled aluminum minibox, 2 jacks (our J2 and J3), a DPDT slide switch (S2), plenty of hardware, and instructions for mobile mounting. Set aside the box, read the instructions and then note the following changes (Fig. 3). Since B- must be isolated from the chassis, and since the pre-drilled mounting holes on the

converter board pass through B-, try pre-mounting it on a thin piece of perforated masonite board, 1 $\frac{1}{4}$ " x 5", as a buffer, after drilling 4 separate holes in the latter to mount the complete assembly in the chassis, and after connecting 3-inch flexible leads to points V, T and U. Along the narrow edge of the board, near L6 and the nearest mounting hole to it, measure and drill a  $\frac{5}{32}$ " hole to accommodate the projecting and locking tip of C11, the output peaking padder of the TRC-4B. Identify the hot side of C11, run the orange lead from terminal V to it, with about  $\frac{3}{4}$ " more extending beyond, to reach J3. Mount the padder with the 4-40 hardware provided. This automatically grounds the other side of C11 to the peripheral foil conductor. Now, using the hardware provided, including spacers, in the 3 remaining corner holes, mount the TRC-4B to the platform, foil side down and components up. It may be necessary to bend the 3 female connectors slightly, to make them fit between the converter and its platform. In the corner

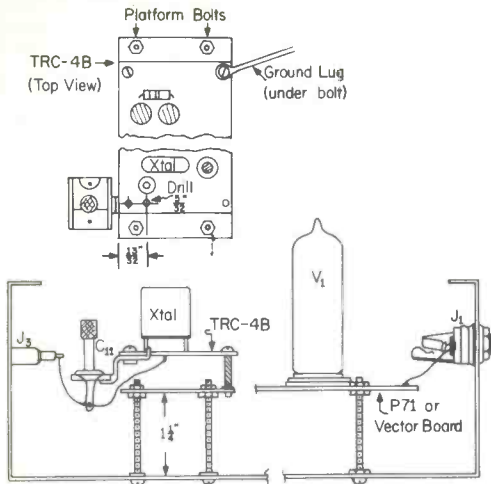

Fig. 3. Mounting of C-11, the TRC-4B converter board and the transmitter board.

nearest Pt. U, slip the long grounding lug under the bolt head, letting it extend diagonally out from that corner when the bolt is fastened.

When the paint is dry, mount and wire the fuse extractor post, S1, S2, J2 and J3, and the AC receptacle, leaving color coded flexible leads long enough to reach the circuit boards and other components that will follow. Leave terminal 1 on S2 blank. Leads to the transmitter must be dressed under the converter board. R10 should be mounted on a long 6-32 bolt above the line cord rubber grommet, with an insulating washer at the chassis end. Tighten the bolt with the resistor terminals facing upwards.

Mount and wire the filter capacitor, C7, except for the negative lead. Now wire the silicon diode and protective resistor, R11, between one fuse post and R10, being careful to observe diode polarity, and to protect the diode from overheating while soldering. (Use long-nosed pliers or alligator clip as a heat sink.) Mount pi network assembly, HP57, with 1 flexible lead (slated for Pt. B) pre-wired. The output can be connected directly to the lead from S2.

Run 8 two-inch 6-32 bolts (from the converter kit) up from the chassis bottom with lock washers and nuts on the inside to hold them rigid. These will serve as "Vector" or PC board mounting posts. On each, run 2 nuts down to 1 1/4" from the bottom, as a platform to set the height of the boards (Fig. 3). Mount the transmitter board carefully on its

## PARTS LIST

- 1 V1 12AU7 oscillator tube
- 2 V2, V3 50C5 power and modulator tubes
- 3 Printed circuit tube sockets (1-9 pin, 2-7 pin) (Lafayette MS-150-151 or Allied 45H526-45H527)
- 1 8" x 12" x 3" aluminum chassis
- 1 T1 Carbon mike transformer (Stancor A4705, or equivalent)
- 1 T2 Modulation transformer (Lafayette TR-12 or Allied 62G023)
- 1 SO-1 Crystal holder (Lafayette MS-786 or Allied 72-50-75)  
Xtal(s) Citizens' Band 3rd overtone type crystal (Channel & quantity optional)
- 1 R.F. choke, 2.5 mh.
- 1 L1 Oscillator coil (Lafayette HP 60)
- 1 L2 Pi Network (Lafayette HP 57)
- 1 SR Silicon diode—500 ma., 400 P.I.V.
- 1 J1 2 conductor, single closed circuit jack (Switchcraft PJ 57, or equivalent)
- 1 S1 SPST toggle switch, with solder terminals
- 2 J2, J3 Automobile type antenna jacks
- 1 S2 DPDT slide switch
- 1 Mic Single button carbon microphone with press-to-talk switch and 3-conductor coiled cord
- 1 R1 22K, 1/2 w.
- 1 R2 82k, 1/2 w.
- 1 R3 2.2k, 1 w.
- 1 R4 27k, 1 w.
- 1 R5 33 ohm, 2 w.
- 1 R6 150 ohms, 1 w.
- 2 R7, R8 4,700 ohms, 2 w.
- 1 R9 2,700 ohms, 1/2 w.
- 1 R10 100 ohms wirebound, 10 w.
- 1 R11 10 ohms, 1 w.
- 4 C1, 6, 8, 9 100 ufd. disc, 200 w.v.
- 1 C2 10 ufd. disc, 200 w.v.
- 1 C3 500 ufd. disc, 200 w.v.
- 1 C4 1,000 ufd. disc, 200 w.v.
- 1 C5 30 ufd., 12 w.v. (Lafayette CF 175)
- 1 C7 50 ufd./50 ufd., 150 w.v. paper electrolytic
- 1 TRC-4B 11 meter converter p.c. board—International Crystal Mfg. Co., Oklahoma City, Okla. (Cat. No. 300-145, \$14.50 postpaid in U.S.)
- 1 P-71 Transmitter p.c. board—Projects Unlimited, 58-14 84th St., Elmhurst, L. I., N. Y. (\$4 postpaid) (optional)
- Misc. Line cord, plug, fuse extractor post and 3AG 400 ma. fuse, perforated aluminum sheet (15" x 12"), assorted hardware

4 bolts, foil side up, lettered terminals B-G toward the control apron. Fasten with nuts, plus special hardware for terminal side, as follows: Under the nut nearest Pt. B, mount a grounding lug. Under the nut nearest Pt. G, mount an insulating washer.

Mount J1 with fiber shoulder washers to insulate its ground terminal from the chassis. Connect the live terminal to Pt. A, and the other side terminal to the outside (B-) conductor at F'. Connect and solder lead of C8

to the ground lug near Pt. B. Connect all remaining power supply and control leads to appropriate terminals except G. Insert line cord through grommet, tie strain relief knot, and solder to the S1 terminal that is not connected to the fuse post. Mount converter platform on 4 remaining mounting posts, and tighten with nuts. Solder ground lug from TRC-4B and second line cord lead to B-bus on the transmitter. Connect T lead to the blank terminal of S2.

Prepare a short length of RG-58AU cable with a plug at one end, to connect the receiver terminal of the transceiver (J3) to

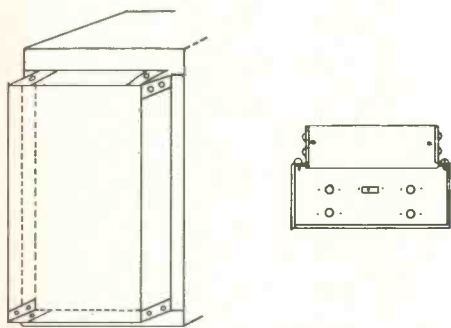
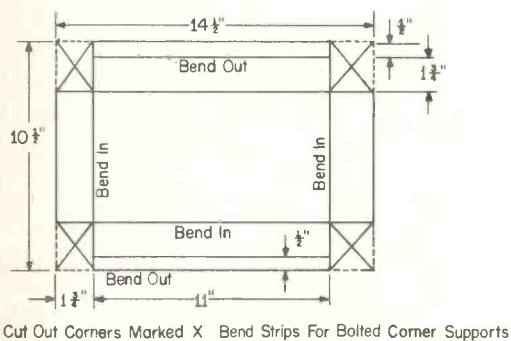

Fig. 4. Layout of the shield. Although an optional feature, it should be used as a TVI eliminator.

the antenna circuit of the associated broadcast receiver, through a 100 uuf. capacitor (C9) in series with the live conductor. The shield at the receiver end of the cable must be clipped off and not connected to the receiver chassis. Ground return is achieved by plugging the receiver line cord into the AC receptacle on the Transceiver chassis.

Prepare a second and longer length of RG-58AU cable with a plug at one end, to connect the antenna terminal (J2) to the antenna to be used.

Prepare the proper plug to match microphone cord to J1.

Now, take the time to check all wiring. G should be the only point not connected.

### OPERATION

After inserting crystal, tubes, 400 ma. fuse, line cord and all connecting cables, connect a dummy load (such as a #47 pilot lamp) between the antenna terminal and the chassis. With S2 on Receive position, turn on power. Observe to see if tubes light. If all is well, switch to Transmit. Using a grid dip meter as an output indicator (plate off), tune the oscillator coil for maximum meter deflection at the frequency desired. This may or may not cause the lamp to glow, depending on the degree of resonance of the power output stage. The latter is then also tuned to give a similar deflection on the grid dip meter. Tune the antenna loading capacitor. By now, the lamp should glow. Returning to the oscillator coil and repeating the process should result in sharper tuning and maximum lamp brilliance. Now, check audio by using microphone and seeing if voice modulates lamp. (Before the antenna cable can be substituted for the lamp or dummy antenna, the holder of at least a Second Class Commercial FCC License must check the unit to see that you have constructed it properly and that it is functioning within Part 19 regulations.)

Switching back to Receive, check the voltage and polarity of Pt. G to ascertain that it is +8 to +15 volts, with reference to the B-bus. If so, turn power off, and solder lead from Pt. U to G. Now turn power on again, and switch on broadcast band receiver, too. Follow TRC-4B instructions for adjustment of C11. This completes testing and adjustment of the AC/DC CB Transceiver.

Controls can be identified by appropriate decals. A decorative and utilitarian shield can be prepared from perforated aluminum sheet, by following the layout in Fig. 4, and bending the sheet carefully as described. Four self-tapping screws are used to fasten the shield to the chassis flange. Rubber feet can also be screwed to the chassis bottom.



# Recommended **TOPS** in **CB**

BY THE MEN WHO USE...AND THE MEN WHO SELL

## UTICA

Our customers and dealers tell us this and we are grateful. We put our very best into every unit we make and back each one with a complete guarantee. The same satisfaction our customers express can be yours to enjoy . . . try UTICA.



### UTICA **TEC II** TRANSCEIVER

With all the deluxe features and performance you could possibly want. A new dual conversion 6 channel crystal controlled transceiver with tunable receiver. S meter and signal strength output indicator, external crystal socket, auxiliary speaker terminal and universal power supply are only a few of the many plus features that make the T&C II outstanding. Deluxe chrome cabinet ..... **199.95**

### UTICA *Town & Country* **MC-27** TRANSCEIVER

A handsome, rugged, top performer. The MC-27 is a dual conversion 6 channel crystal controlled transceiver with exceptional sensitivity and selectivity. Features Double Gated Noise Suppression Circuit, Automatic Volume Control with improved squelch circuit and universal power supply Deluxe chrome cabinet ..... **179.50**

On the go . . . at home or at work . . . you're there with UTICA

## UTICA CUSTOMIZED ANTENNAS FOR EVERY CB PURPOSE



### UNIVERSAL ANTENNA SELECTOR BOX

For fast switching from base station to Horizontal or Vertical Beam. **7.50**



### GIZMOTCHY 2 in 1

Vertical - Horizontal Beam Antenna for hi-efficiency and greater distance base station performance ..... **55.95**

### BUDDY WHIP

96 inch fibre glass mobile antenna with unique pivot base that permits immediate antenna adjustment to any position from driver's seat ..... **24.50**



### GROUND PLANE

Heavy duty ground plane antenna pre-matched for 52 ohm impedance **24.50**

Write for details  
Dept. S9-1

# UTICA

COMMUNICATIONS CORP.

2917 W. Irving Park Rd.  
Chicago 25, Illinois

Sold thru Leading  
Distributors Everywhere



# THE N.B.Q.M.

"THE NO BUCKS Q-MULTIPLIER"

ADDS SELECTIVITY AT LOW COST

by HARVEY HURWITZ, 2W2921

The constant search for more and better selectivity often leads to the investment of a considerable amount of cash. It is not impossible to achieve the same results with a total outlay of about 75¢.

One of the interesting things about an IF amplifier stage is that there is a rather simple way of varying its selectivity and gain. If you create a condition whereby this stage is operating with a controlled amount of regeneration, there is a sharp rise in the gain of the stage along with a sharp rise in selectivity. It is entirely possible to narrow down the band pass on this stage to the point where an AM phone signal will be badly clipped and distorted. Since we do not wish to go quite this far, the modifications shown include a method of controlling this effect so that the operator may select a point where results are optimum. The actual modification requires *only one part*. This is a 5,000 ohm audio taper control.

Mount this control on the front panel of your rig reasonably close to the second IF tube. (Note: Some units contain only one IF tube.) Using your schematic, locate the cathode of this tube (typically-pin 7-6BJ6). This tube-pin will be connected directly to ground, or grounded through a low value resistor and .05 capacitor.

Disconnect the ground or the grounded end of the resistor. Connect a piece of insulated hook up wire between this point and the center arm on the 5,000 ohm control.

If your unit does not have a small disc capacitor running from the cathode terminal to ground, it must be added at this time. Use a .05 disc ceramic and connect it between the cathode terminal on the socket and ground. In some units there will be an additional connection between the screen grid

1

Original IF Stage

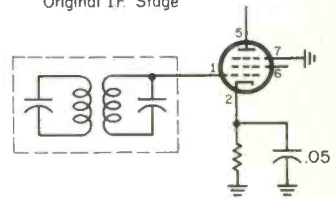

2

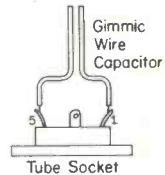

3

New

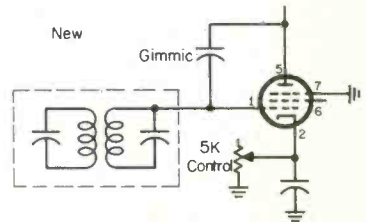

of this stage and the cathode. As shown in the schematic, the screen grid must now be grounded directly. Remove any link between the screen grid terminal and the cathode terminal before grounding the screen grid.

Connect one of the end lugs on the control to ground. Once again refer to the schematic and select the grid and plate contacts on the IF tube socket. (Caution, remove the tube before attempting to make any solder connections to the socket. Excessive heat may cause the tube base to crack.)

Cut two pieces of single conductor insulated hook up wire to a length of 1½ inches. Strip ¼ inch of insulation off of one end of each wire. Carefully solder the stripped end of one wire to the plate terminal on the tube socket. (Pin 5-6BJ6). Similarly solder one end of the other wire to the grid connection. (Pin 1-6BJ6). Band these wires as shown in the sketch so that they are parallel to, but not touching, each other.

In effect, you have just created a capacitor that will couple the grid and plate circuits together creating a regenerative feedback condition. This feedback can be controlled by varying the distance between the two wires and by the control previously installed.

Check carefully for shorts and poor joints. Replace the tube and, without replacing the cover, turn the set on. When the set has warmed up and with an antenna connected you may hear a howl from the speaker. Set the control to its mid point. Carefully move the two wires apart until the howl just stops. (If no howl is produced at any setting of the control, move the wires closer together). By carefully adjusting this control and the wire spacing you should be able to get a regeneration howl just before the control reaches minimum resistance. Set the control to a point just before the howl starts and tune across the band. You should note that there is a rather sharp peak on incoming signals. If this peak is *too* sharp and the audio appears distorted, simply turn the control so as to add more resistance until the signal sounds satisfactory.

If your unit is equipped with an RF gain control it is wise to reduce the gain in the RF stage. The additional gain provided by the now regenerative IF circuit will more than compensate for this reduction. At this point you may replace the cover being careful not to disturb the setting of the two wires.



Special club subscription rates for 59

# SAVE \$60.00 GUARANTEED BRAND NEW GLOBE CB-100A TRANSCEIVERS A WRL SPECIAL BUY



**\$89.95**  
Singly

**NOW \$79.95 ea.**  
(Lots of 2 or more)

## FOR HOME-CAR-OFFICE-BOAT

A special quantity purchase enables WRL to offer the famous Globe CB-100A at such a low price. Features 3 channel selection, fully xtal controlled. 10 tube rec/xmitt, 5 watts AM. Carry handle for, tilt stand, mobile or permanent mtg. 3½ x 13 x 10½", 13 lbs. Includes coil cord, mike and crystal for one channel (no choice), and 115vac power cord -12V cord \$3.49 optional. Shipped Express.

## IMPROVE CB RECEPTION SATISFACTION GUARANTEED!

MODEL NA-27

**\$11.95**  
POSTPAID



WRL'S 2 STAGE  
NUVISTOR PRE-AMPLIFIER

Improves Reception on any CB  
Transceiver, Receiver, Superhetrodyne  
or Regenerative Circuits.

Small (2¼ x 2¾") install internally

Fixed or Mobile-6 or 12V

Finest printed Circuitry

QUANTITY  
DEALER  
DISCOUNTS

WRITE FOR FLYER

**WRL** WORLD RADIO LABORATORIES

3415 W. B'away • Council Bluffs, Ia.

Send me rush, F.O.B. WRL:  Globe CB-100A,  
\$79.95.  CB Pre-Amplifier, (Postpaid) \$11.95

9-1

Name \_\_\_\_\_ Call \_\_\_\_\_

Address \_\_\_\_\_

City \_\_\_\_\_ State \_\_\_\_\_

the

# BIG 11

MODEL BXR-10

## CITIZEN BAND BASE ANTENNA A NEW STANDARD FOR ALL CB ANTENNAS

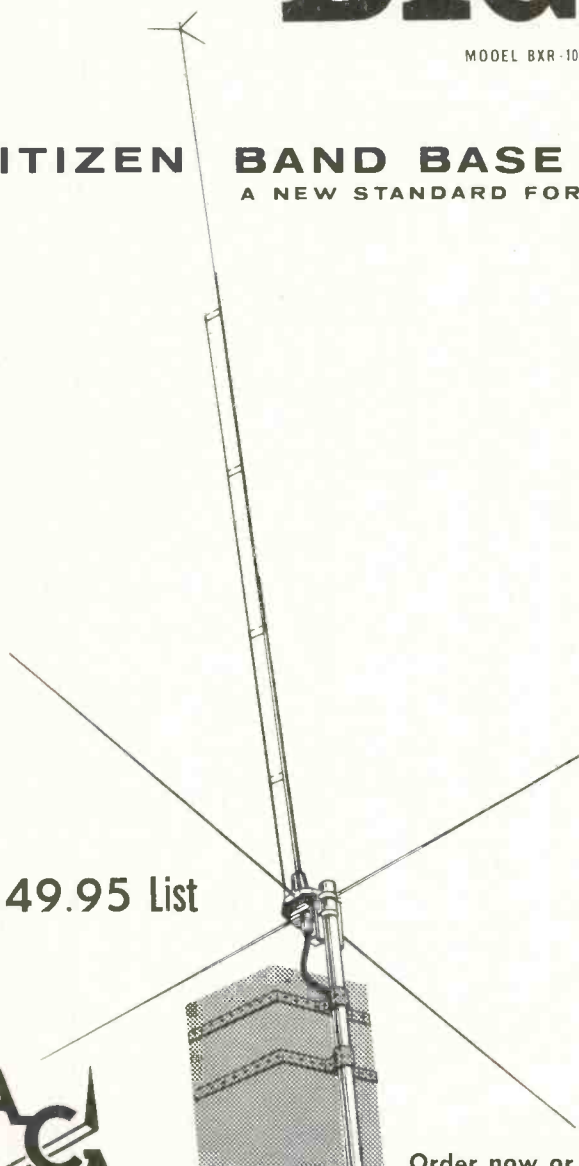

**Performance:** The "Big 11" vertical ground plane permits 360 degree radiation with incomparable efficiency. The Top Hat design, developed by A.C.A. and used with our other antennas, has been effectively incorporated into the "Big 11" to eliminate skip reception and give low angle to radiation. Parallel Matching ("L-Match") gives a maximum S.W.R. of 1.1 to 1 over all 23 channels with a 25db. gain in signal to noise ratio, thus permitting your power to radiate instead of being dissipated as line loss.

The "Big 11's" unique design features provide better performance than conventional  $\frac{1}{2}$  wave-length verticals and yet is five feet shorter. This gives the "Big 11's" radiating element maximum height away from obstructions and trees.

**Construction:** The "Big 11" Base Station Antenna has a three-sectional solid aluminum rod radiator with an overall height of only thirteen feet. The radials are also solid aluminum rod with a total length of 52 inches per radial. The "Big 11's" ruggedized base assembly is weatherproofed to eliminate variations in S.W.R. Coaxial cable can be directly coupled to the "Big 11" by means of a standard PL-259 connector. U-bolt assemblies with non-slip plates facilitate single mast mounting. Once assembled and mounted, the "Big 11" needs no tuning or adjustment. All components on the "Big 11" are anodized to minimize corrosion and pitting — and remember A.C.A.'s warranty of one year on all components.

\$49.95 List

**ACA**

ONE YEAR WARRANTY  
ON ALL PARTS

Order now or write for free literature!

**STUART** ELECTRONIC DISTRIBUTORS, INC.  
79-12 Parsons Blvd., Flushing 66, N.Y. — OL 7-6868

# FOR EMERGENCY PURPOSES

## USE YOUR RIG AS A PUSH TO TALK P.A. SYSTEM

by JIM GIBSON, 2W7610

The use of Citizens Band equipment in both mobile and marine service has grown at a tremendous rate. Yet in both services, there are many occasions where a simple public address system or *loudhailer* can prove highly valuable.

The typical CB rig contains an efficient push to talk audio amplifier of two or three watts output capacity. This amplifier can be utilized to drive a horn type outdoor speaker with sufficient audio for most any conceivable purpose. In order to utilize this amplifier we must first arrange to disable the transmitter portion of the unit. This is most easily done by installing a double pole throw switch in the cathode circuit of this tube. Typically, we would locate the cathode of the final (Pin 7 on a 6CX8, 6AW8, 6AU8). This point will normally be con-

nected to ground through a resistor. In many rigs, this resistor is connected to a switch or relay which is grounded in the transmit cycle only.

Carefully disconnect the ground side of this resistor. Mount a double pole throw switch at any convenient point on the front panel. Connect a twisted pair of wires from one of the center terminals either of the end terminals on the same side of this switch (solder) to the now disconnected end of the cathode resistor and the point from which it was removed (see schematics A and D; solder). This completes the modification of the final.

When this switch is closed, the transmitter will operate normally. Mark this position "T." When the switch is open the transmitter will be disabled. Mark this

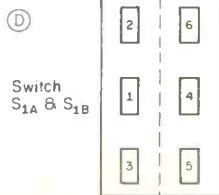
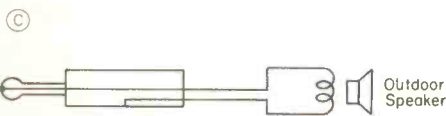
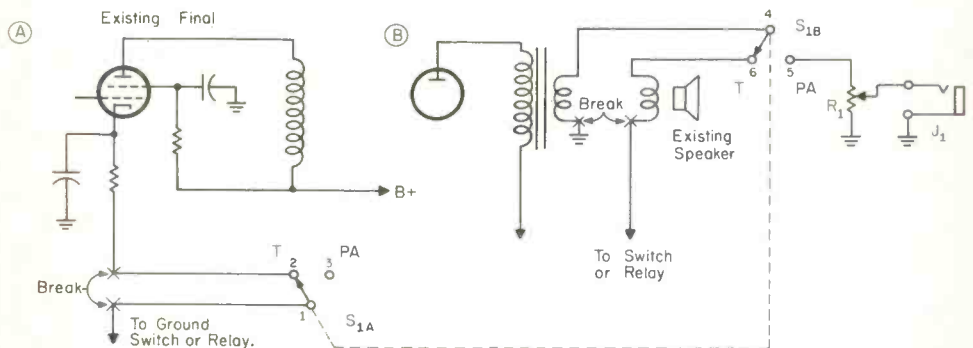

### PARTS LIST

- 1 Double Pole Double Throw switch
- 1 20 ohm wire wound potentiometer
- 1 Phone jack with matching plug



position "PA."

The addition of the external speaker is the next step. Locate the wire that is connected to the ungrounded end of the existing speaker. One end of the speaker is connected directly to the output winding of the modulation-output transformer. This is the wire that we need. The other end of the speaker is usually connected to a relay or the mike switch. *Do not disturb this lead.* Break the lead that is connected between the speaker and the modulation transformer. Connect the end from the transformer to the center terminal on the as yet unused side of the Double Pole Double Throw Switch previously installed (see schematic B and D; solder). Using an ohmmeter select the terminal on this switch that is connected to the center terminal when the switch is in the "T" position. Connect the lead that goes to the existing speaker to this terminal (solder). Mount a 20 ohm wire wound potentiometer at any convenient point on the front panel. Connect a new lead between the terminal on the DPDT switch that is connected to the modulation-output transformer when the switch is in the "PA" position (solder), and one of the end terminals on the 20 ohm pot. Connect the other end terminal on this pot to ground (solder both). Mount a small output jack (RCA, Amphenol, etc.) on the rear of the transceiver. Be sure that the ground lug is well soldered or mechanically bonded to the chassis. Connect a new lead between the center terminal on the jack and the center terminal on the 20 ohm pot (solder both). This completes the modification of the transceiver.

Check all connections for open or cold soldered joints. Mount a 4 ohm outdoor type speaker on the deck, fender, etc. Connect a two wire cable to the lugs on the speaker. Run this cable to the transceiver. Staple or otherwise secure this cable out of the way of feet, moving parts, etc. Solder the proper plug on the end of this cable and attach the plug to the jack that you mounted on the transceiver.

Now, turn on the rig and place the switch in the "T" position. The unit should work normally and the outdoor speaker should not operate. Place the switch in the "PA" position. At this point you may hear Citizens Band reception through the outdoor speaker. Reduce the volume on the regular volume control until this can no longer be heard. Press the push to talk button on your mike and speak into it. You should hear the audio through the outdoor speaker. The volume control on your unit will have no effect on the outdoor speaker at this time. The new control that you have installed is now used to set the volume of the outdoor unit. Rotate this control either clockwise or counter clockwise until maximum volume is developed. If you observe any feedback (loud squeal) slowly reduce the output level until the feedback disappears. To return the set to normal operation, simply flip the switch from "PA" to "T." The outdoor speaker may also be used to monitor the channel by simply setting the switch to "PA," turning up the new output level control to maximum and setting the receiver volume control to the desired level. To transmit, you must switch from "PA" to "T."

The completed installation now enables you to utilize your CB rig in the normal fashion. When the need arises you can at the flip of a switch use the unit as a push to talk public address system. As the transmitter is disabled during this type of operation there is no possibility of inadvertently being on the air as you speak. Since this system will develop a considerable amount of audio output, it would be wise to conduct your tests in a relatively deserted area. Many local communities prohibit the use of a mobile public address system except under emergency conditions or with a proper permit. No such restrictions apply to marine use.

**SEND for our FREE Booklet NOW!**

## **TIPS for the CB User**

Save money! Save time! Find out how to make your own Preventative Maintenance Check on both your mobile set and base station. A complete listing of tips valuable to every CB user is available now from

**CREATIVE PRODUCTS INC.**

6944 Plainfield Road • Cincinnati 36, Ohio

**Write for your FREE copy today!**



# PART 15 KORNER

by DEAN DETTON, NORTHERN 17

% S9 MAGAZINE  
300 WEST 43 ST.  
NEW YORK 36, N. Y.

This column is dedicated to the Part 15 enthusiast—the “hundred milliwatter,” the guy with the flea powered rig and the BIG signal. As we all know, hobby use of Part 19 licensed 5-watt gear is *strictly verboten*, so sayeth Uncle Sam—however our kindly uncle has given us the green light to “whoop it up” under Part 15 rules so long as we don’t cause any interference to Part 19 stations.

We have therefore set up our tents on 8 channels upon which Class D stations cannot operate and we can now operate to our hearts content without fear of treading upon the feet of our bigger 5-watt brothers. Our 8 channels are:

Channel A	26.995 mc/s
Channel B	27.045 mc/s
Channel C	27.095 mc/s
Channel D	27.145 mc/s
Channel E	27.195 mc/s
Channel F	27.235 mc/s
Channel G	27.245 mc/s
Channel H	27.265 mc/s

So far, Channel A seems to be the most active for “phone” stations, Channel B the most popular for CW enthusiasts.

Listening around we heard a nice 5 station CW network operating on Channel B—all of the stations were using S9’s Part 15 identifiers and upon checking them out we

*Continued on page 59*

## APPLICATION FOR FREE PART 15 STATION IDENTIFIER CERTIFICATE

To register your Part 15 “unlicensed” CB station with S9 and receive your special station identifier certificate, do the following:

- Fill in the application below, or facsimile if you don’t want to cut your copy of S9.
- Enclose your completed application form together with a self-addressed stamped (5¢) envelope, in another envelope addressed as follows:

Part 15 Department  
S9 Magazine  
300 West 43rd Street  
New York 36, N. Y.

- Please do not request special identifying words for your station as all identifiers are issued in alphabetical rotation for ease of recording on our records.

## APPLICATION FOR PART 15 IDENTIFIER

Name: \_\_\_\_\_ CB Call: \_\_\_\_\_

Address: \_\_\_\_\_

City: \_\_\_\_\_ Zone: \_\_\_\_\_ State: \_\_\_\_\_

Part 15 Channel: \_\_\_\_\_ Type of unit: \_\_\_\_\_

No. of units: \_\_\_\_\_ Date: \_\_\_\_\_

Signature: \_\_\_\_\_

# Build the WORLD'S CHEAPEST TUBE TESTER

CHECK THOSE TUBES FOR LESS THAN A DOLLAR!

by HAROLD BROWN

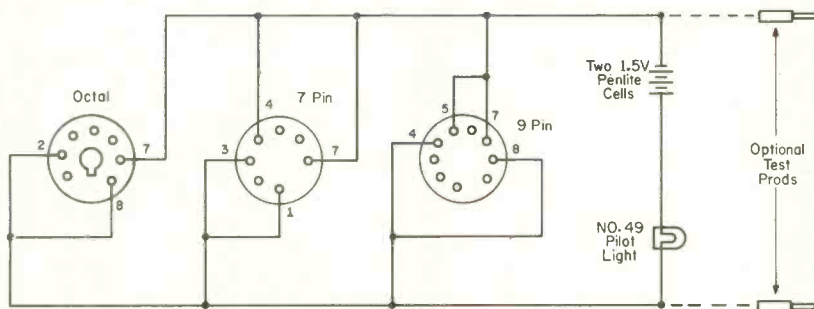

Perhaps you may have, from time to time, considered purchasing a tube tester to keep around the CB shack. Tube testers run from \$20 for kit to well over \$500 for intricate models.

But did you know that you can detect the cause of the majority of tube break-downs by a simple "junk box" wonder? Well you can—and this article will give you all the details.

Regular tube testing devices put the tube through what might be considered an "A-to-Z" series of tests which will let you know all sorts of intimate information on your little 6AQ5, 6BA6, or whatever. But is this really necessary? I have found that the majority of my tube problems were simply the fact that the filament burned out—just like a light bulb. So why not construct a simple tube tester which will check *only* to see if the filament is still intact? That's exactly what I designed, and here are the details so that you can build one yourself.

Construction of the unit is very simple. It took just a little over an hour, including the time spent searching for parts in the junk box. The chassis is a plastic box which once contained shower curtain rings. It was a little too large, but economy was more important here than size. Any material may be used,

## PARTS LIST

- 1 Octal tube socket (Amphenol 77MIP8 or equiv.)
  - 1 7 Pin tube socket (Amphenol 77MIP7S or equiv.)
  - 1 9 Pin tube socket (Amphenol 77MIP8T or equiv.)
  - 2 1.5 volt penlite cells (Eveready 912 or equiv.)
  - 1 No. 49 pilot lamp
  - 1 Socket for pilot lamp (Dialco 708 or equiv.)
- (optional) Small plastic box, battery holder, optional test prods.

since the wiring is not grounded. If a metal box is used you may want to ground one leg of each circuit if it's more convenient.

The holes were made by using an *old* soldering iron to melt the plastic. This method is not advisable if you don't want to ruin a new iron.

The seven and nine pin sockets are attached by screws. The octal socket is a forced fit with the plastic moulded into the grooves with the hot iron tip.

The battery is held in place by a pair of terminal strips. These strips also hold the pilot light and the connections from the sockets.

A small hole burned through the plastic will hold the bulb snugly. If you're using a

*Continued on page 58*

# HERE FROM TRAM

For those CB'ers who appreciate the difference . . . **TRAM**



## RECEIVER

Sensitivity - .1 uv. for 300 milliwatts of audio

Selectivity - 6 db. @ 5 kc. Adjacent channels 60 db. down

Signal to noise - .3 uv. or better for 10 db.

R.F. Stage Noise Figure - 2 db. or better

## TRANSMITTER

RF Output - 3.5 watts minimum

Modulation - to 100%. Keyed audio compression - highest average modulation ever.

Flexibility - 23 channel operation is standard equipment.

Is WHY you hear and are heard better, even under seemingly impossible conditions of range, noise and location. An honest, fair comparison is the only test of superiority. We dare to compare. Prove TRAM is second to none *yourself* - 10 day, money-back trial period.

Why move to a house on a hill or put your antenna 200 feet in the air? Buy a TRAM, it's easier.

No matter what you have, you can still upgrade to

**TRAM THE BIG DIFFERENCE IN CB TODAY!**

To hear from TRAM by return mail, write to:  
for detailed information and specifications.



**TRAM ELECTRONICS**

P. O. BOX 187, DEPT. B, WINNISQUAM, N. H.

add more  
voice punch  
to your  
CB rig...

less  
10-9 and 10-1  
more "solid"  
10-4's

**SHURE**  
**201 CB**  
ceramic  
improvement  
microphone



### "SHAPED" VOICE RESPONSE

. . . patterned after professional mobile and SSB amateur radio response curves . . . assures maximum intelligibility.

PROFESSIONAL QUALITY DESIGN, CONSTRUCTION . . . performs as good as it looks.

"ARMO-DUR" VIRTUALLY INDESTRUCTIBLE CASE . . . shock-shatter-corrosion-rust-and-weather-proof.

LONG-LIFE SWITCH . . . guaranteed a full year.

SUPERIOR COILED CORD . . . won't kink, crack, peel or lose resiliency.

"LIFETIME" HANG-UP BRACKET . . . positive lock in, easy snap out.

CB net model 201—\$10.80

Write for literature:

SHURE BROTHERS, INC.

222 Hartrey Avenue, Evanston, Illinois





Trade in Your  
Present C/B  
Equipment on  
**HAMMARLUND**  
CB EQUIPMENT

**\$5 DOWN**  
*three years to pay*



**NEW CB-23**  
**\$229.50**  
**Only \$8.10**  
a month  
(3 years)

FIRST crystal controlled 23 channel CB Transceiver within the reach of the average CB'er. Works on 110 VAC & 12 VDC.

**HQ-105TRS**

**\$229.95**

**Only \$8.10**

a month (3 years)



Now be able to listen to all short wave bands from broadcast to 30 mcs. as well as have a single channel transmitter for 11 or 10 meters. Convert to 8 transmitting channels by adding CB-8—110 VAC only.

Low Payments on Hammerlund CB

	1 yr.	2 yrs.	3 yrs.
HQ-105TRS	\$229.95	\$20.57	\$11.22 \$8.10
CB-23	229.95	20.57	11.22 8.10
CB-8	15.95	—	—

**AMATEUR ELECTRONIC SUPPLY**

To: Amateur Electronic Supply  
3832 W. Lisbon Ave., Milwaukee 8, Wisconsin

Ship me a \_\_\_\_\_ on channel \_\_\_\_\_ (1 Free).  
Please install Extra Channels for \_\_\_\_\_ (\$5.95 per channel).  
I Enclose \$\_\_\_\_\_. I will pay balance (if any)  
in:  C.O.D.  1 Year  2 Years  3 Years  
For:  110 VAC & 12 VDC  110 VAC & 6 VDC  
See page 40 for credit information.

I want to buy a \_\_\_\_\_ and want to trade  
a \_\_\_\_\_ which was originally purchased in:

Kit form  Wired

In this form this unit originally sold new for

\$\_\_\_\_\_. I purchased it  New  Used.

Name \_\_\_\_\_ Call \_\_\_\_\_

Address \_\_\_\_\_

City \_\_\_\_\_ Zone \_\_\_\_\_ State \_\_\_\_\_

Send FREE listing of used CB & Ham gear.

**PHOTO —**

By **JOHN A. COMSTOCK**

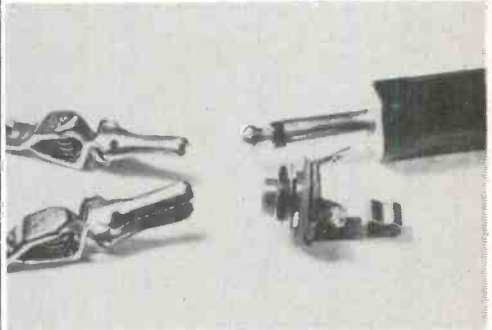

"Honey, I'd like you to meet our new neighbors, Mrs. Plug and her husband Jack."

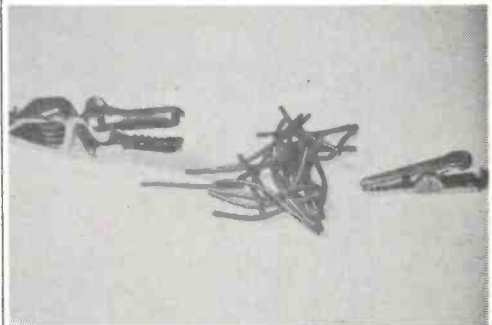

"Eat your spaghetti, Junior."

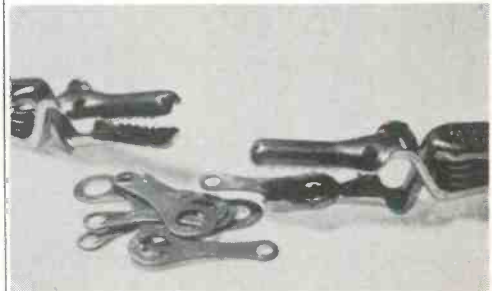

"Dammit Clara, you know I like lots of solder on my lugs—what's the idea of just finning them?"

Write to our advertisers for special product news

# - TOONS

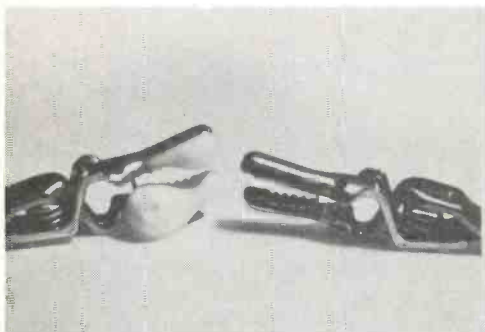

"Clem, that battery was leaky. Gimme a Bromo."

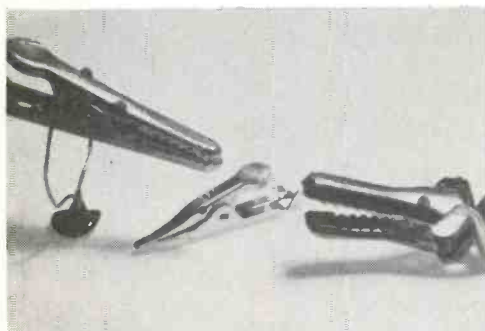

"Dr. Gator, little Micro won't eat his spaghetti."

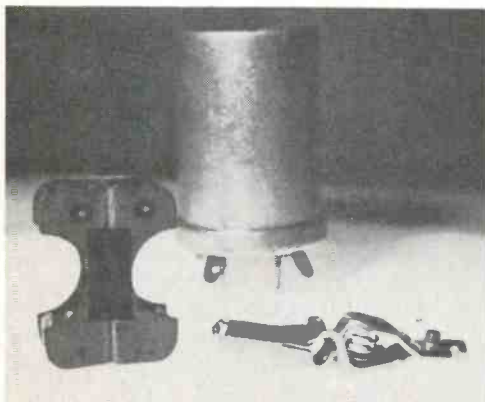

"KLATU BORATO NEKTORI!" ("Take me to your leader.")

Watch for next month's big issue



Trade in Your  
Present C/B  
Equipment on  
**POLYTRONICS**  
CB EQUIPMENT

**\$5 DOWN**  
*three years to pay*

POLYCOM "N"  
\$189.95

Only \$6.67  
a month (3 years)



'Very popular' is the perfect description for this 4 channel "Nuvisistorized" CB Transceiver.

SR-23  
\$349.95

Only \$12.45

a month (3 years)



The ultimate in CB Rigs—all 23 channels at your fingertips. Tone call system! Message light! "Nuvisistorized" S meter.

Look at these Low-Low Payments of \$5.00 Down Payment on any Polytronics Rig

	1 yr.	2 yrs.	3 yrs.
SR-23	\$349.95	\$31.62	\$17.24
PC-N	189.95	16.95	9.24
Polytuner	34.95	—	6.67

You'll be amazed when you get our trade-in!

## AMATEUR ELECTRONIC SUPPLY

MILWAUKEE 8, WIS. CHICAGO 31, ILL. ORLANDO, FLA.  
3832 W. Lisbon Ave. 6450 Milwaukee Ave. 23 Azalea Park  
PHONE WE 3-3262 PHONE RO 3-1030 Shopping Center

To: Amateur Electronic Supply  
3832 W. Lisbon Ave., Milwaukee 8, Wisconsin

Ship me a \_\_\_\_\_ on channel \_\_\_\_\_ (1 Free).  
Please install Extra Channels for \_\_\_\_\_ (\$5.95 per channel).  
I Enclose \$ \_\_\_\_\_. I will pay balance (if any)  
in:  C.O.D.  1 Year  2 Years  3 Years  
For:  110 VAC & 12 VDC  110 VAC & 6 VDC  
See page 40 for credit information.

I want to buy a \_\_\_\_\_ and want to trade  
a \_\_\_\_\_ which was originally purchased in:

Kit form  Wired

In this form this unit originally sold new for  
\$ \_\_\_\_\_. I purchased it  New  Used.

Name \_\_\_\_\_ Call \_\_\_\_\_

Address \_\_\_\_\_

City \_\_\_\_\_ Zone \_\_\_\_\_ State \_\_\_\_\_

Send FREE listing of used CB & Ham gear.



# ON THE COUNTERS

Man, like new CB transceivers are really out in full force for the new year, so we might as well get right into it.

Firsty, Jack Shea, formerly with the CB sales division of RCA has just joined the CB division of ITT, so it's a pretty fair bet that we can look to ITT to be coming up with some interesting new CB gear to celebrate the event. Jack's "hep" on what CB'ers want and he's got some very clever ideas and innovations under his fedora. ITT's address is P.O. Box 99, Lodi, N. J.

Lafayette Radio (111 Jericho Turnpike, Syosset, L. I., N. Y.) popped in for New Year's with their HE-90 transceiver which



sells for less than \$95 (less mobile power supply). The unit transmits on 6 channels. Receiver-wise, the HE-90 has a superhet receiver (tunable plus 6 fixed) with 1 uv sensitivity via a Nuvistor in the front end. It has 3 stages of IF. Other interesting features are crystal spotting and a TVI filter.

Metrotek Electronics, Inc. (205 W. Cabarrus St., Raleigh, N. C.) has a hot little unit called the "STARFIRE" under wraps. We were interested to learn that the Metrotek engineers really gave the unit the full

soup-to-nuts treatment in its design. Features are super receiver, a most unusual transmitter with a novel modulation circuit. The unit is expected to sell for around \$110 or less.

DeWald (35-15 37th Ave., Long Island City 1, N. Y.) announces their R-1050 rig



which features 6 transmit and receive channels, plus tunable, Nuvistor front-ended superhet receiver, TVI trap, S and plate meter and 3 IF stages. It lists for less than \$120.

Browning Labs (100 Union Street, Laconia, N. H.) has caused quite a stir with their new M-523 mobile rig. The unit features all 23 channels (crystals included) for transmitting and receiving—yet packaged in a cabinet so small that it is half the size of this page with the book turned on edge. This makes it dandy for boats and cars—and it has been designed so that none of the features of the regular Browning base station units were omitted or compromised. It's got a transistorized DC power supply, modern styling, and a receiver with adja-



cent channel rejection of 60 db. Accessories include an S-meter and an AC power supply. The M-523's price is in the \$260 category.

Globe Division of GC Electronics (400 S. Wyman Street, Rockford, Ill.) has released their new "GLOBE MASTER" rig to the CB world. This new unit features a sensitivity minimum of 10 db signal plus noise to noise ratio with half-a-microvolt input to the antenna. The selectivity has 6 db points at 6 kc/s and 60 db points at 25 kc/s. The unit has 11 transmit and fixed receive channels, plus tunable, crystal spot-

ting and an S-meter. It sells in the \$230 price category.

The real "shocker" of the month is *International Crystal's* brand new EXECUTIVE MODEL 1500, and is one is *totally* different than *anything* ever before placed on the market *anywhere*—and it's an S9 scoop!

The EXEC 1500 is an *entire* base station built to comply with FCC rules and regulations for maximum utilization of *Part 15*. Briefly, this means **NO LICENSE NEEDED**, *full* hobby use *legally* permitted

*Continued on page 34*

# Pep up your tired CB rig...



## with the new TURNER 355C

New for Citizens Band and other mobile operation, the 355C and its cool brother 356C feature top performance, durability and style.

Both these new models come complete with hanger button and standard dash bracket for easy mounting. Equipped with 11" retracted, 5 foot extended coiled cord, wired for relay operation. Response: 80 to 7,000 cps. 355C output level is -50 db, 356C output is -54 db. Please specify model number when ordering.

MAIL COUPON FOR COMPLETE SPECIFICATIONS.

GENTLEMEN:

Please send literature on your Citizens Band microphones.

**MICROPHONE COMPANY**

933 17th Street N.E., Cedar Rapids, Iowa  
IN CANADA: Tri-Tel Associates, Ltd.  
81 Sheppard Avenue West  
Willowdale, Ontario

Name

Address

City  State





**NEW from *hallicrafters*...**  
**a truly reliable**

*Accessories  
for greatest versatility!*



**AC POWER SUPPLY—CBP-1**  
Styled as matching pedestal  
for CB-5. Operates on 117V,  
AC power supply.



**PORTABLE PAK—CBB-1**  
12V nickel cadmium recharge-  
able batteries. Battery life up  
to 8 hours before recharging  
with self-contained charger.  
Flexible, continuously-loaded  
fiber glass whip.

**TONE-CODED SQUELCH—CBT-1**  
Full duplex, four transistors.  
Installs inside CB-5 cabinet—  
no soldering. Fully automatic.

# **CB-5** Citizens Band Transceiver

*hallicrafters*



**CHANNEL**



**SQUELCH**

The marvel of transistors . . . unchallenged communications experience . . . and a big dose of patience: It took the right amount of each to bring you the most imaginative, most practical CB transceiver ever designed.

Let's start with size. 10¼" x 8¼" x 3¼". You can install it in the glove compartment of a Volkswagen and still have room for gloves.

You can operate it all day with less battery drain than it takes to start your engine once. (You can start the engine with the CB-5 "on", too — no vibrator.)

Performance? If you like figures, try these for size:

5 watts in; 100% modulation capability; 1 uv sensitivity for 10 db. S/N ratio; 45 db. adj. channel rej.; 6.0 kc. selectivity @ 6 db.; 300-3,000 c.p.s. audio @ 3 db.; 18 transistors, 9 diodes, 3 instant-heating transmit tubes for complete reliability and 100% modulation. In short — superior.

Convenience? Six crystal-controlled channels (same mil. spec. CR23/U crystals used in all Hallicrafters CB equipment). PTT ceramic mike. Less than seven pounds light (it's aluminum). Self-contained PM speaker. Electronic squelch.

If you think the CB-5 has possibilities — wait until you read about the accessories.

For illustrated brochure with complete specifications, visit your Citizens Band dealer or write Dept. 9-A, Hallicrafters, 5th & Kostner Aves., Chicago 24, Ill.

## transistorized CB transceiver

\$199<sup>95</sup> accessories optional extra

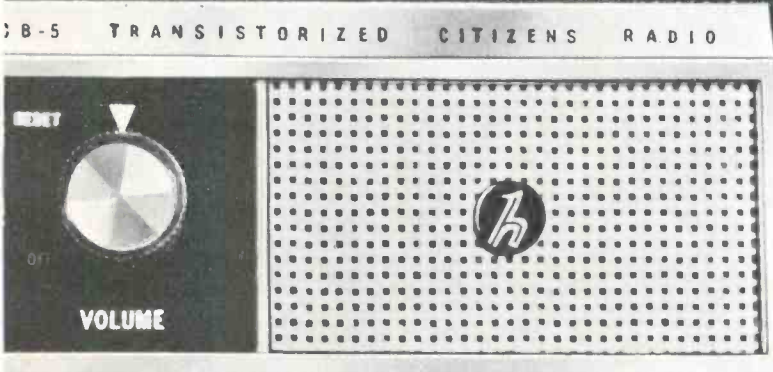

## ON THE COUNTERS

*Continued from page 31*

by FCC, and all the other goodies discussed in S9's Part 15 issue (December). In fact, the general layout of the EXEC 1500 station is similar to the "ideal" Part 15 station pictured on page 10 of our December issue.

The station comes complete for operation on all eight of the Part 15 channels ("A" through "H") and will transmit both AM and un-modulated CW (the long distance type) through the mike and telegraph key provided with the station. Also included in the station is 100 feet of coaxial cable, a choice of either of two antennas available, the tower for roof mounting, all crystals for 8 channel operation.

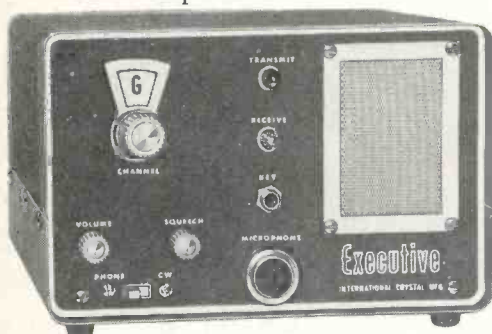

The rig itself looks similar to the EXEC 100 outside, and features 110 VAC power supply, BFO (for CW operation), and squelch. The receiver has a highly sensitive preamp located with the final amplifier in a metal box which is mounted atop the antenna tower to provide maximum signal output from the transmitter from the receiver. The transmitter has a 100 mw final—we understand that it gave *astounding* results during factory tests (using S9 Part 15 identifiers *WESTERN 11* through *15*), running only a fraction of an S-unit below many of the local 5-watt Part 19 stations in the area. It looks like the EXEC 1500 station will be the answer to the prayers of many CB'ers who wish that they could *legally* use 11 meters for hobbying—especially in view of the pending FCC regulations to clamp down on Part 19 users. The entire station sells in the \$300 class, which is reasonable when you consider that you have nothing else to buy to be on the air. Information on this novel unit can be obtained by filling in our special Reader Service Card which is in the forward section of this issue of S9.

Here's a photo of the "BIG 11" antenna from *Aerospace Communications Antennas*

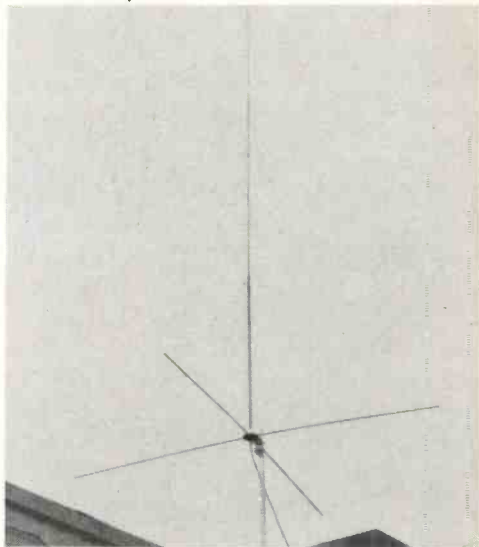

(P.O. Box 698, Stamford, Conn.) This antenna is a heavy-duty type made specifically for industrial and lists in the \$50 class. It's a 1/2-wave type, 13 feet in height and the manufacturer claims it has a 1.1 to 1 SWR across the entire band.

Last month we described a test unit called the "PORTALAB" from *e.c.i. Electronics Communications, Inc.* (325 N. MacQuisten Parkway, Mt. Vernon, N. Y.). We thought that you'd like to see a photo of this snazzy unit so the gang at *e.c.i.* obliged



us with this one. It's black and chromium really sleek.

*Premax Products, Division of Chisholm-*



Ryder Co., Inc., Niagara Falls, N. Y. is a well known name in industrial antennas. They have hit the CB market with a number of rugged mobile whips and will be happy to send full details and an illustrated catalogue to all S9 readers.

E. F. Johnson (Waseca, Minn.) has their new 10-channel "Messenger Two" out now. Ideal for commercial installations, the rig has increased sensitivity and high adjacent



channel rejection, also extra-quiet new noise-limiter circuitry. Priced in the \$170 class, the unit is available in 2 basic models—one for 115VAC/6VDC and one for 115VAC/12VDC.

The folks at *General Radiotelephone* (3501 Burbank Blvd., Burbank, Calif.) have a few surprises up their sleeve too! First, they have a new Single and Double Sideband adapter which measures about 2

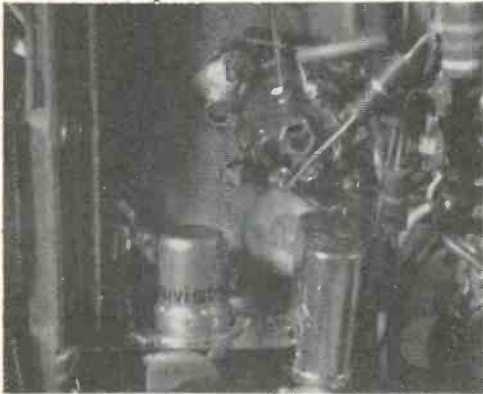

cubic inches and hooks into MC3, 4, or 5 rigs in about 20 minutes! This is the first such adapter on the market and it sells for less than \$20! Now, this adapter works only on the receiver section, the transmitting adapter will be out in about 30 days and sell for about \$80. This is about as

## "YOU'VE GOT FREE FCC WARNING STICKERS?"



Yes! **FREE FCC WARNING STICKERS** we've got—and we'll be glad to send you one if you subscribe to S9 NOW! These are the **BIG** anodized heavy-duty aluminum self-sticking ones, not little plastic decals or the chintzy stuff printed on tinfoil. Just our way of saying an extra "thank you" to our readers. These have sold elsewhere for a buck and are well worth it (if you want to buy one *without* the subscription that's what we'll charge you!). Past subscribers can get one **FREE** while we're still in the Holiday mood—just drop us a card and ask.

Of course this is to say nothing of the fact that you'll be getting yourself a 12-time ride on the S9 bandwagon—12 issues chock-full of all kinds of interesting, useful and worthwhile CB views, news, reviews. Treat yourself to the leader—we've got some pretty big things coming up in the next few issues which *you can't afford to miss!* **SEND! NOW!**

Use the postage-free envelope hidden in the back of this issue!

Rates: 12 issues—	\$5
24 issues—	\$9
36 issues—	\$13

**S9 MAGAZINE**  
**300 West 43rd Street**  
**New York 36, N. Y.**



**ORDER NOW**  
**IMMEDIATE**  
**DELIVERY**  
**FROM STOCK**



**UTICA**  
**T & C II TRANSCEIVER**

With all the deluxe features and performance you could possibly want. A new dual conversion 6 channel crystal controlled transceiver with tunable receiver. S meter and signal strength output indicator, external crystal socket, auxiliary speaker terminal and universal power supply are only a few of the many plus features that make the T & C II outstanding. Deluxe chrome cabinet. . . . 199.95

10% down **\$20<sup>00</sup>** (\$199.95)

Order Today  
 From Hamateur Headquarters

**THE Lew Bonn co.**

Distributors of Nationally Known Amateur Equipment

Dept. 591 67 South 12th St., Minneapolis 3, Minn.

Call, write or use coupon

Attn: Joe Hotch Federal 9-6351

- Place my order for immediate delivery. Enclosed find \$ \_\_\_\_\_
- Send complete specifications on Utica T & C II Transceiver

Name \_\_\_\_\_ Call letters \_\_\_\_\_

Address \_\_\_\_\_

City \_\_\_\_\_ Zone \_\_\_\_\_ State \_\_\_\_\_

inexpensive way as you could imagine to take advantage of SSB or DSB.

They also have an interesting little, and we do mean *little*, industrial type 5-channel rig just out, the VS-2. This mighty little devil has got more goodies crammed into



its 4½ by 6½ by 9 inch case than many "big" sets have in twice the size. To name but a few, cascaded RF amplifier, 2 IF stages, series noise limiter, Zener diode noise clipper, 5 channels, pi-network output, moisture proof mike, electronic switching, transistorized power supply, leatherette-type cabinet, chassis is steel, copper with cadmium and gold plating. This is designed for use in fork-lift trucks, jeeps, farm equipment, etc. and can really take a beating. They even made sure that the buyer won't take a beating at the counters because it sells for less than \$140! And wait until you hear its signal—WOW!

Hey, CB'ers in northern Florida and Southern Georgia, a new CB shop just opened up in your neck of the woods. Drop in to see Hank Paul there at *Parts Unlimited of Jacksonville*, 2636 Atlantic Blvd., Jacksonville. Hank carries many lines of equipment and also S9—of course!

By the way, information on all equipment mentioned in this column may be had directly from each of the companies, or by filling out the "Reader Service Insert Card" in this issue and mailing it to our office.

**Free!**  
**PAGE 35!**

# S9 Lab Reports

## THE LAFAYETTE HE 66 WALKIE-TALKIE

Lafayette Radio has just released the new HE-66 "Walkie-Talkie." This unit (for less than \$20) provides a full crystal controlled superhet receiver and an 85 milliwatt trans-

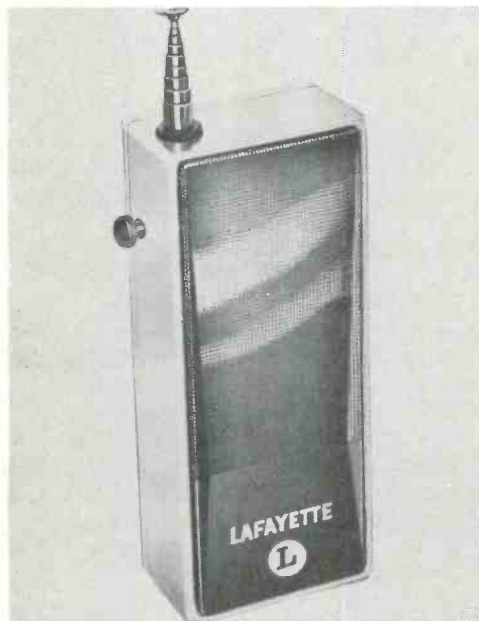

mitter utilizing four transistors and one diode. Its small size make this a true pocket set 2½ W x 6 H x 1½ D. A leather carrying case is provided along with crystals and six pen-light batteries.

Tests made with this unit disclosed a range of up to one mile over land and up to a surprising 8 miles over water. The unit appeared well made and battery life appeared satisfactory.

Lafayette hangs out their shingle at P.O. Box 10, Syosset, L. I., N. Y.

## MULTI-PRODUCTS CD-7 CITI-FONE

Multi-Products (21470 Coolidge Highway, Oak Park 37, Mich.) is an interesting outfit. A long, long time ago they hit the market with their CD-5 Citi-Fone which sold like mad while the company sat back

“S9 ОНИ БУДУ  
ЩЕ КОНСТРУК?”



С помощью подвижного комплекта аппаратуры обеспечивается измерение и регистрация фазового угла одной из компонент горизонтальной составляющей поля относительно фазы тока в кабел **pages 48 and 49** вижной (измерительной) аппаратуры входит приемная катушка с ферритовым стержнем. Для уменьшения электромагнитных помех и помех

Rates: 12 issues—	\$5
24 issues—	\$9
36 issues—	\$13

**S9 MAGAZINE**  
300 West 43rd Street  
New York 36, N. Y.

Support free enterprise — SUBSCRIBE TO S9!



Trade in Your Present C/B Equipment on **NEW GONSET COMMUNICATORS**

**\$5 DOWN**  
*three years to pay*



**G-15 \$199.95**

**Only \$7.04 a month**  
(Three Years)

**G-15 HAS TUNABLE 23 CHANNEL RECEIVER PLUS PANEL SIGNAL STRENGTH METER**

Both the Gonset G-15 and G-14 are our service manager's (George Brennenstuhl) favorite Citizens Band rigs. Some of the reasons he gives are: Full 100 per cent modulation (clipped and compressed)—High degree of efficiency—Extremely Selective (little or no adjacent channel interference)—Adjustable transmit frequency (each channel can be zeroed in)—Lots of audio output—Double conversion receiver is crystal controlled—four channels Xtal controlled in addition to Tunable Receiver.

G-14 similar to G-15 as pictured but less S meter and tunable receiver (\$149.95 or just \$5.00 down and \$5.23 a month).

Both G-15 and G-14 are complete with AC and DC cords, Microphone and Mounting Bracket.

For special credit-ordering information see page 40.

**AMATEUR ELECTRONIC SUPPLY**

Three Stores to Serve You

MILWAUKEE 8, WIS. CHICAGO 31, ILL. ORLANDO, FLA.

3832 W. Lisbon Ave. 6450 Milwaukee Ave. 23 Azalea Park

PHONE WE 3-3262 PHONE RO 3-1030 Shopping Center

PHONE 277-8231

**SEND MAIL ORDERS TO MILWAUKEE STORE**

Amateur Electronic Supply

3832 W. Lisbon Ave., Milwaukee 8, Wisconsin

Ship me a \_\_\_\_\_ on channel \_\_\_\_\_ (1 Free).

Please install Extra Channels for \_\_\_\_\_ (\$5.95 per channel).

I Enclose \$\_\_\_\_\_. I will pay balance (if any)

in:  C.O.D.  1 Year  2 Years  3 Years

For:  110 VAC & 12 VDC  110 VAC & 6 VDC

See page 40 for credit information.

I want to buy a \_\_\_\_\_ and want to trade a \_\_\_\_\_ which was originally purchased in  Kit form  Wired

In this form this unit originally sold new for

\$\_\_\_\_\_. I purchased it  New  Used.

Name \_\_\_\_\_ Call \_\_\_\_\_

Address \_\_\_\_\_

City \_\_\_\_\_ Zone \_\_\_\_\_ State \_\_\_\_\_

Send FREE listing of used CB & Ham gear.

quietly and filled orders. Later they brought out the CD-6 and, after a relatively long quiet period, they have now brought out their latest (and best) unit, the CD-7.



Unlike the CD-6, which was an improved CD-5, the new CD-7 is completely new from the panel to the plugs. Starting at the front, where all good sets start, the panel is really slick with black and gray trim, a little (not too much) chrome and a dash of red.

In the electronic department, the CD-7 is just as sharp as it is in the looks department. The transmitter selects any of 5 internally installed crystals, or 1 from a front panel socket. Other features of the transmitter are adjustable pi-network output, full 100% modulation, harmonic (TVI) output at least 60 db down, hi-Q tank coil.

The receiver features both fixed tuning and variable with a crystal spotter, two double tuned IF stages, 1/2-uv sensitivity for a 10:1 S-N/N ratio, and "noise immune" type squelch circuit which operates at a tenth of a uv of signal above the noise level.

There's a vibrator power supply and a dual meter which reads S-units and relative power output of the transmitter.

The circuitry includes a 6AQ5 modulator, 6AQ5 final, and 6BJ6 front end. All in all, 9 tubes.

Getting the rig on the air for some practical tests, we were impressed by the 11 page instruction manual which certainly wouldn't leave much to chance with a newcomer to CB.

The rig checked out as well as, or better than, the manufacturer's specifications and the lab wattmeter checked the output at 2.9 watts, the modulation right on the button of 100% at normal speaking voice.

We noted that the CD-7 has a vernier

# BOOST RECEIVER SENSITIVITY TO 10 TIMES!

The NEW Raytronics NUVISTAPLUG gives up to 25 db gain when inserted in the RF amplifier tube socket of any receiver (CB, Ham, TV, FM, etc.). Cuts noise figure from about 6 db to less than 3 db. No wiring or circuit changes! Replaces directly in socket of any 7 pin pentode RF amplifier. Warrantied for 90 days! When ordering, state type of tube the NUVISTAPLUG will replace (6AU6, 12AU6, 12BA6, 6CB6, 6BZ6, 6DC6, 6DB6, etc.). Money back guarantee if you are not satisfied.

**ONLY \$17.95**

postpaid N.Y.C. res. add 3% sales tax  
(No C.O.D.'s)

**RAYTRONICS**  
% S9 MAGAZINE  
300 West 43rd Street  
New York 36, N. Y.

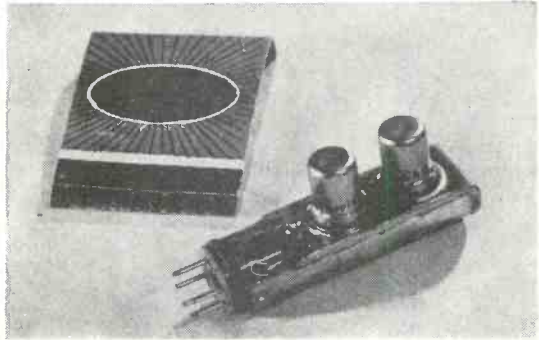

Have you noticed those **SE-100**  
**EXTRA LOUD**  
California  
stations?

**Only \$34.95**



Well they're probably using the AUDIO RAM. It supplies the extra "punch" most rigs leave out. The AUDIO RAM is the only transistorized preamp, clipper and compressor on the market, yet costs less than inefficient tube rigs. Compact? You bet! Measures only 2 1/2" x 2 1/2" x 4" SE-100 with self contained battery and modulation meter. superbly styled

**SE-101**  
**Only \$24.95**



The SE-101, lowest cost unit of its type available. The same rock crushing performance of the SE-100 but at less cost. Features in-out switch for comparative reports, rugged construction and the low-low cost of \$24.95. No need for a separate power supply, either model for use with mobile and fixed station equipment.

**STONER ELECTRONICS**  
Box 7388 Alta Loma, California



Write for free instruction manual and data sheets

THIS MONTH'S BRAINWASHING: *Subscribe!*



Sweet Talking... **GLOBE ELECTRONICS**



**THE GLOBE MASTER CITIZENS BAND TRANSCEIVER**

A new Achievement in CB transceiver excellence. 22 Channel Reception. 11 channel broadcast. Built-in S-Meter, spot switch, superior modulation with adjustable clipping, are all part of this great unit. Send for free spec sheet now. See coupon below.

## FREE WHEN YOU BUY the MASTER

The Globe Citizens Band Book tells you everything you must know to operate CB. What you can and can't do. Installation tips, which antenna, base or mobile, CB language. It's all here. A regular 2.00 value, compiled by experts. Free with every CB transceiver from Globe exclusively.

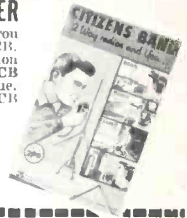

**SEND \$1.00 FOR A COPY NOW...**

Like a copy of this great book now? Use the coupon below and enclose 1.00 cash or money order for each copy.

GC ELECTRONICS CO., 400 S. Wyman, Rockford, Illinois,

Rush me the Globe Master Spec sheet Name \_\_\_\_\_

Send me \_\_\_\_\_ copies of the CB Book. I enclose 1.00 for each copy. Address \_\_\_\_\_

City \_\_\_\_\_ State \_\_\_\_\_



**INFORMATION REQUIRED FOR A TIME PAYMENT  
PURCHASE AT AMATEUR ELECTRONIC SUPPLY**

(see our ads in this magazine  
on pages 28, 29, 38, & 47)

Even if you are not ready to make a purchase on credit today, send me the following information on a separate piece of paper. Do not put it in the body of a letter. If you have a message to send us enclose it with the credit application on a separate piece of paper. Once your credit has been ok'ed you will receive an attractive card showing that you are a preferred credit customer. All at no cost to you. List the following information on a separate piece of paper very carefully, accurately, and complete in every detail for quick credit approval:

1. Your full name. Your age. Your Driver's License Number and state in which it is issued.
2. Your wife's name (if any). Her age. Number of children (if any) and their ages.
3. Your complete home address. How long have you lived there? Your telephone number, or nearest phone where you can be reached.
4. List your previous address. How long were you there?
5. If you rent, show the amount of payment. Also name, address, and phone number of landlord.
6. If you own your own home, show the amount of payment (if any). The mortgage holders name, address, and phone number.
7. Show name of employer, his address, and phone number. Your occupation. How long you have been there. Salary by the week.
8. Show previous employer, his address, and how long there.
9. If your wife is employed, show name of employer, address and phone number. Her occupation, and weekly salary.
10. If own a car, show year and model. If it is financed, show by whom and their address.
11. If you own your furniture, state so. If it is being financed, show by whom and their address.
12. List the names and addresses of banks with whom you do business with.
13. List at least five credit references, giving the complete street address, city and state. If you owe anything to these people, show the amount owed, and briefly the items purchased.
14. List at least two relatives and one friend not living with you.
15. Indicate the amount of credit desired and the length of time you desire credit. For instance, \$1,000, for 36 months.

Send the above information to speed  
a time payment purchase to:

**AMATEUR ELECTRONIC SUPPLY**

3832 W. LISBON, MILWAUKEE 8, WISCONSIN

tuning dial and its 8 to 1 ratio makes for easy tuning of those fellows who seem to have a hair of a signal which many other sets would have a hard time trying to pin down. Drift was negligible after about 15 minutes of warm-up. We were impressed with the lack of adjacent channel interference in this rig—really nice!

We found the CD-7 to be a well designed and rugged unit which will adapt itself well to both home and commercial uses. Certainly it has been designed with the user in mind and will stack up favorably with the standards we have all established in our minds as to how a "good set" should operate. Certainly it is one of the better rigs in its price class (\$190).

**DELPHI ELECTRONICS  
MODEL 112  
FIELD INTENSITY METER**

The use of metering in all phases of transmitter alignment is one of the salient points in most modern equipment. One of the areas in which metering has been neglected is in the province of actual radiated field intensity or strength. The DEI model 112 Field Intensity meter provides a simple, sensitive and inexpensive solution to this problem. With a working range of 50 KC through 500 MC at an average sensitivity of .02 Volts RMS, this unit will enable the user to assure proper tuning for maximum output. This appears to be the most sensitive such device offered in the lower price field. The high sensitivity of this unit also allows its use as an RF detector when checking out oscillators, buffers, and similar devices where the field strength is quite low. As a bonus feature, this unit may also be used to monitor modulation with 100% providing  $\frac{1}{8}$  scale needle deflection when set at mid-scale reference points.

This unit measures approximately 2" x 2" x 1½" and is mounted in a grey crackle finish case. A short solid rod antenna is provided and should suffice for most field measurement problems. Rubber feet are provided on the cabinet or it may be ordered with an attached magnetic clamp for mobile use.

Manufacturer is *Delphi Electronic Instruments Corp.*, 57 South Grand Ave., Baldwin, New York. Price class is \$14.00.



# The Standard for Comparison!

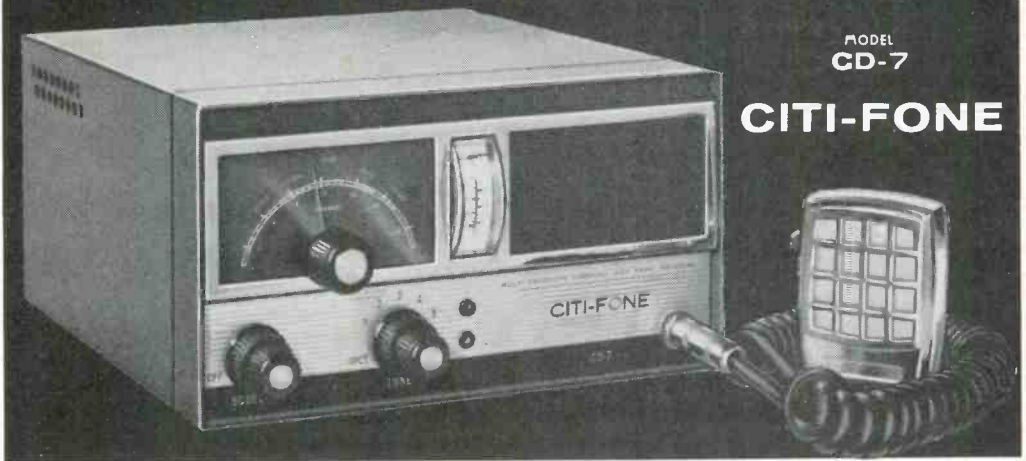

MODEL  
CD-7

**CITI-FONE**

**DESIGNED FOR THE DISCRIMINATING USER WHO DESIRES QUALITY AND RELIABILITY AT A REASONABLE PRICE. COMPARE PERFORMANCE BEFORE YOU BUY AND YOU'LL BUY CITI-FONE.**

See your nearest dealer today or write for full specifications to Dept. M-8  
MULTI-PRODUCTS COMPANY • 21470 COOLIDGE HIGHWAY • OAK PARK 37, MICHIGAN



"I got an FCC citation. You got any apology cards?"

The BIG Switch Is To S9

## this "S" Meter



Model  
540

Indicates your signal strength instantly  
**ONLY \$1388 NET**

- A SECO PLUS—the first transistorized "S" Meter on the market . . . introduces no loading on AVC circuit!
- Ideal for CB, AM and FM tuners, ham, TV, and antenna orientation
- Illuminated "zero" to "30 db over 9" meter—also controls for zero set and sensitivity
- Completely self powered—operates on standard 9 v battery
- Can be built right into your set or attached anywhere with suction cup base
- Styled to make a handsome matching set with the Seco Signal Filter noise limiter and controllable squelch

See your electronics distributor or use the coupon below to order your Seco Model 540 "S" METER.



**SECO ELECTRONICS, INC.**

1241 S. Clover Drive, Minneapolis 20, Minn.

Please send (Qty) \_\_\_\_\_ "S" Meters postpaid

check.  money order for \$ \_\_\_\_\_ (\$13.88 each) enclosed.

PRINT  
NAME \_\_\_\_\_

ADDRESS \_\_\_\_\_

CITY \_\_\_\_\_

STATE \_\_\_\_\_

January 1963 • S9 • 41



# COURIER 1-M

---

NOW!

# QUIETEST

---

# MOST POWERFUL

# MOBILE C.B. UNIT!

# HEAR IT TO BELIEVE IT!

Write for Free Brochure ..... \$209.50 list, slightly higher west of Rockies.



electronics communications, inc. 325 no. macquesten pkwy, mt. vernon, n. y.

# ECHO

COMMUNICATIONS INC.  
Cedarburg, Wisconsin

## YOUR COURIER HEADQUARTERS



SANDY WIRTH  
KHA 2175-W9BTN  
Write me for CB



**BOOST YOUR POWER**

**\$159<sup>50</sup>** prepaid or

**\$14<sup>50</sup>** down and

**\$13<sup>30</sup>** per month  
for 12 months,

**\$7<sup>25</sup>** per month for 24 months

### LINEAR AMPLIFIER

... *Illegal on 11 meter band in the U.S.A.*

## PORT-A-LAB

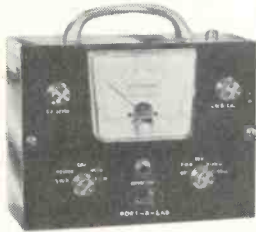

**THE PORTABLE CB  
CHECK-OUT LAB**

Only

**\$44<sup>95</sup>**

prepaid to your door

## antenna specialists

**M-81 MAGNUM** base antenna

**FREE** with every Courier 1-M

or only

**\$24<sup>87</sup>** prepaid to your door

Only at ECHO

WISCONSIN DEALER INQUIRIES INVITED

## COURIER 1-M



### • Tops in C. B. Transceivers

- TRIPLE CONVERSION
- 12 Channel Transmit
- R.F. "S" meter (lighted)
- Lighted 23 channel tunable
- R.F. Gain Control
- Proven Quality

only **\$209<sup>50</sup>**

*All Couriers Fully Guaranteed*

or **\$19<sup>50</sup>** down and **\$17<sup>42</sup>** per month  
for 12 months,

**\$9<sup>50</sup>** per month for 24 months.

## ECHO Communications, Inc.

Box 223 Cedarburg, Wisc.

Phone DR 7-3800

- O.K. "Sandy" here is my down payment of \$14.50 please Rush forms to cover Linear Amplifier for  12 months  24 months.
- Attached is \$159.50 please ship Courier at once prepaid.
- Attached is \$44.95 please ship Port A Lab at once prepaid.
- Attached is \$24.87 please ship Magnum M-81 Base Antenna Prepaid.
- Attached is \$19.50 to cover down payment for Courier 1-M. Please rush forms for  12 months  24 months.
- O.K. "Sandy" here is \$209.50. Ship me a new Courier 1-M and Magnum Antenna prepaid today.

NAME \_\_\_\_\_

ADDRESS \_\_\_\_\_

CITY and STATE \_\_\_\_\_

Please Send Literature.



# CB ANSWERMAN

by LEN BUCKWALTER, KBA4480



**Editor's Note:** Readers are invited to ask the CB ANSWERMAN any questions which they have regarding the CB service. Address your questions to Len Buckwalter, KBA4480, Wilridge Road, Georgetown, Conn.

## RUBBER CRYSTALS

I notice that all-channel CB rigs are beginning to appear with something called frequency synthesis. Does this mean that they have 46 crystals—23 for receive and 23 for transmit?

H. J. I., Chicago, Ill.

No, they contain far less than 46 crystals. Frequency synthesis is a clever method of using few crystals to do the work of many. Someone sat down at a design board and made the interesting discovery that a mere 11 crystals can be mixed in various ways to produce 46 frequencies needed for all-channel coverage.

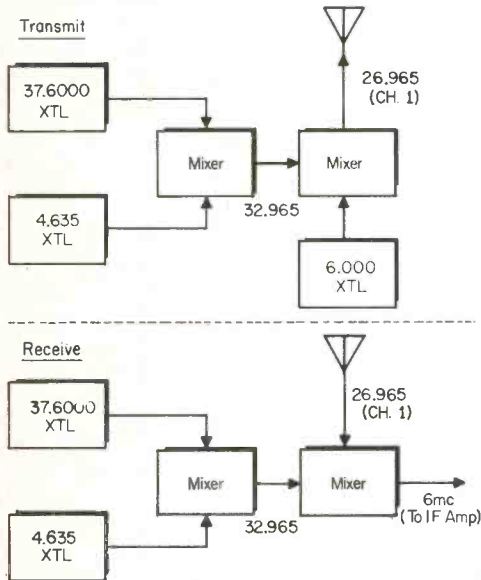

Here's an example of how it works (see illustration). Let's say you flip the rig to channel 1 and wish to transmit on 26.965. Unlike other trans-

mitters, a 26.965 rock is not selected. Two crystals are energized; on 37.600 and 4.635. Their signals are mixed and a difference of 32.965 is created. As shown in the drawing, a second mixing process occurs, this time with a 6 MC rock. Subtracting 6 from 32.965 we get channel 1 on 26.965. Complicated? Not when you consider that just three out of a possible 11 crystals can combine for 23 transmit channels.

Now let's go to the receiver side. Again the channel switch picks out the two rocks on 37.600 and 4.635. As before, mixing generates a difference on 32.965. This energy combines with an incoming channel 1 carrier on 26.965 and the result is a 6-MC difference. Since the receiver's IF amplifier is designed for a 6 MC operation, the signal is accepted for further processing into audio.

## DISAPPROVED EQUIPMENT

I am looking for a new transceiver and would like to get the list of equipment which does not meet FCC approval.

R. A. S., Los Angeles, Calif.

We know of no such list. In fact, CB manufacturers are not required to submit their equipment to the FCC for type approval. If the unit doesn't live up to FCC specs, the FCC still has no control over the manufacturer. This was stated recently by Mr. Ivan H. Loucks, CB Chief at the Commission. Mr. Loucks explained that the FCC has jurisdiction only over you, the licensee, and not the manufacturer. Thus, if you buy a unit that floats all over the band, you get the ticket.

The answer, therefore, is simply to make your purchase from reputable CB manufacturers.

How is the CB'er protected against a manufacturer who might falsely claim his rig meets the specs? This is the province of another federal agency, the FTC, or Fair Trades Commission. Like the FCC, this branch of the government is understaffed and underfunded, so results often come slowly. But there were some encouraging signs evident in the last year or so. The FTC lowered the boom on at least three frauds operating in the electronics field; a handie-talkie which claimed a

false range, a gadget which gave "amazing" results by "turning your house wiring into a powerful antenna," and a crystal set which claimed fantastic sensitivity. None of the widely advertised CB makers have ever run afoul of the FTC.

#### CODE RECEPTION

I want to use Morse code (CW) between two handie-talkies. Is there a simple way to add tone to the receivers so I can hear the code signal?

F. M., Albany, N. Y.

As you probably know, code is prohibited for Class D stations, however, if the units are used in the "license-free" category (Part 15 of FCC rules), there's no such restriction.

The simplest method we know for making an unmodulated carrier produce tone in the loudspeaker is with a "gimmick" wire. This is a connection in the receiver's IF amplifier that throws the stage into oscillation. A signal is created which mixes with the incoming carrier and an audible tone is heard in the loudspeaker. It's comparable to the BFO, or beat-frequency oscillator, found in ham or SW sets.

The method, described in a moment, works only with superhet handie-talkies. If you have the simpler super-regen type, try advancing the regeneration control until you hear a high-pitched whistle in the speaker. Although the circuit is not intended to function this way, it might work in some cases.

For the superhet, remove the printed-circuit board from the case so you can see the lugs on each transistor socket. While a signal is being received, touch each lug with a fingertip (there's no shock hazard) until you hear tone in the loudspeaker. Just be sure that the tone goes on and off when the sending station keys its carrier. (It is possible to get tone by touching a lug in the audio stage, but sound will remain on all the time.) If you find two different transistors which produce a tone, choose the one which gives better-sounding results. What you have located is a transistor collector or base (usually the former) in the receiver IF amplifier. Now solder one end of a piece of

hookup wire to the terminal. The lead should be long enough to emerge from the case after the board is back in place. Remove a tiny bit of insulation from the free end of the wire and the circuit is ready for use. When you want to receive code, press the tip of your finger to the end of the wire and hold. As your buddy keys the carrier at the other unit, the dits and dahs of Morse code should be heard.

#### WHO GOOFED?

Sir . . . I believe you goofed! You said in the October issue that a gassy tube was of a "hard" condition. According to my FCC handbook, Hornug's Q&A, my electrical dictionary and one heck of a lot of old timers in the business, a gassy tube is one with a "soft" condition.

R. B. J., Sacramento, Calif.

Gassing us on a goof, eh? Read my answer over again—you'll find no such statement. When Mr. T. L. R. asked about blue light in a vacuum tube, the answer stated that it could be from a gassy or hard condition. It went on to explain that the important thing is the position of the blue glow in the tube; if it's between the elements, this means gas—if it's on the inside surface of the glass bulb, the tube is perfectly good. The reason we make such a point of this is that the newcomer might toss out excellent tubes at the sign of the blue light.

But let's put the argument to rest by tapping a final authority, the Electron Tube Division of RCA. In a publication distributed by these boys, the following statement appears: "When a tube is slightly gassy it usually shows a blue glow between cathode and anode . . ." (We all agree on this, but read on) "Some tubes show a fluorescence on the inside of the bulb . . . This is perfectly harmless and may be distinguished from blue glow by its position in the tube."

I read this statement on page 4 of the current "Radiotron Designer's Handbook"—by the blue light from the 6A $\bar{W}$ 8 in my CB final.

Continued on page 60

## MYTIE



## MOBILE

## CARTRIDGE

THIS is the MYTIE MOBILE cartridge.

It is the heart of CRATER LAKE ANTENNAS line of Citizen's Band antennas. With 28" stainless steel radiator, it brings to CB a most effective mobile antenna—totally unaffected by high speeds, trees, even garages, with uniform radiation! Price? Only \$17.95 complete with its silver plated brass base and 12 feet of coax.

The MARINE MODEL is available for only \$26.95. It utilizes the Mytie Mobile as the radiating element and has a special base with three 3/8 inch stainless steel ground plane rods.

### CRATER LAKE ANTENNAS

Box 823

Medford, Oregon

— or —

Box 333 Old Chelsea Station

New York 11, New York

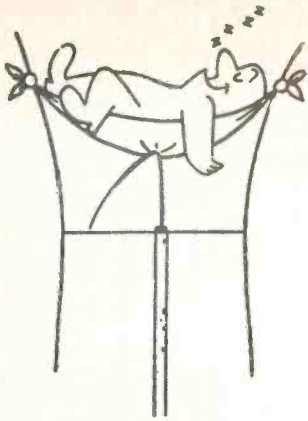

# ANTENNAS

by ED NOLL, KCC2618  
 BOX 23  
 CHALFONT, PA.

## THE COAXIAL VERTICAL

Two of the problems of end-feeding an extended vertical antenna are its basic unbalance and its rising impedance when greater than a quarter-wavelength. Many extended verticals are fed at some other point than the end. Actually a low impedance feed point is available at each maximum current position along its length. For example, it is customary to feed a half-wavelength antenna at the center because this is a low impedance point as shown in Fig. 1.

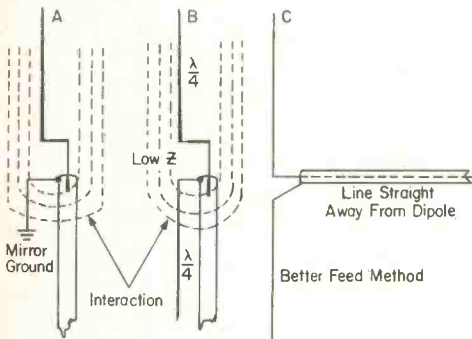

Fig. 1—Coaxial Feed Problems

The unbalanced (not symmetrical) arrangement when end-feeding a half-wavelength vertical can present pattern and line radiation problems. The inner conductor is attached to the radiator; the outer conductor, to a rather *indefinite mirror ground*. The transmission line is in the maximum voltage field of the antenna and current can be induced into the outer conductor of the transmission line. This energy can re-radiate and disturb the vertical radiation pattern of the system. In fact, the vertical radiation angle can be raised and a good attribute of

a vertical antenna is comprised. To some extent this same problem can arise even when center-feeding a half-wavelength antenna if the transmission line runs parallel and close to the radiator as demonstrated in Fig. 1B. Although this later arrangement is a low impedance feed there is unbalance present unless a balun or a more elaborate matching system is used.

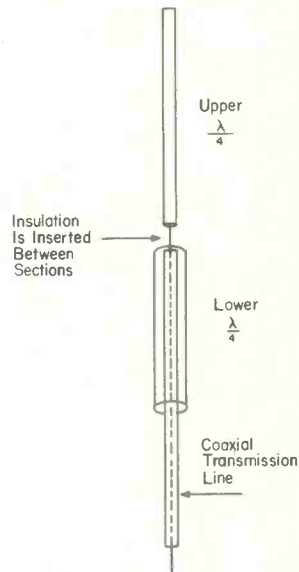

Fig. 2—Coaxial Antenna

The coaxial antenna overcomes these feed problems because the line is fed up through the center of the lower quarter-wave section of the half-wavelength antenna as shown in Fig. 2. The better-balanced coaxial feed system minimizes the induction of energy into the outer conductor of the transmission line by the antenna field. In fact, the lower

section of the radiator is connected to the outer conductor of the transmission line at the center feed point and acts as a shield for the transmission line. The inner conductor of the transmission line connects to the upper quarter-length segment of the antenna.

In summary, the advantages of the coaxial antenna are its balanced low impedance feed (comparable to the characteristic impedance of the transmission line) and its ability to sustain the low vertical radiation angle. The latter is an attractive feature in citizens band operation.

### A LOW-COST COAXIAL

A simple and inexpensive coaxial vertical can be constructed using one-half inch electrical conduit as shown in Fig. 3. The insulator between the two sections is a polystyrene or bakelite tube. Use a wall thickness capable of withstanding the whipping motion of the upper element. The conduit is available in standard ten-foot lengths; these must be hack-sawed down to the proper quarter-wave dimensions for the citizens band.

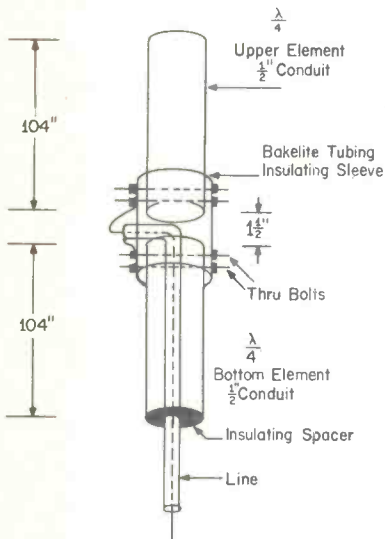

Fig. 3—Home-Built Coaxial Vertical

The transmission line is fed up through the center of the lower element and out through a hole cut in the insulator. Inner and outer conductors are attached to the upper and lower antenna elements respec-

**THIS MONTH'S BRAINWASHING: Subscribe!**

**Trade in Your Present C/B Equipment on JOHNSON CB TRANSCEIVERS**

**\$5 DOWN**  
*three years to pay*



**JOHNSON MESSENGER II**  
**\$169.95**  
**Only \$5.95**  
a month (3 years)

#### NEW MESSENGER II OFFERS

- 10 channels at flip of a switch — illuminated indicator!
- Increased sensitivity, high adjacent channel rejection!
- New . . . high efficiency noise limiter circuit!
- Provision for plug-in selective calling system!

Look at these low payments on all Johnson CB Equipment

		1 yr.	2 yrs.	3 yrs.
Messenger II 10 ch.	\$169.95	\$15.12	\$8.24	\$5.95
Messenger I 5 ch.	139.95	12.37	6.74	—
1 Watt personal Messenger	129.95	11.45	6.24	—
Tone Alerts	59.95	5.62	—	—

### AMATEUR ELECTRONIC SUPPLY

MILWAUKEE 8, WIS. CHICAGO 31, ILL. ORLANDO, FLA.  
3832 W. Lisbon Ave. 6450 Milwaukee Ave. 23 Azalea Park  
PHONE WE 3-3262 PHONE RO 3-1030 Shopping Center  
PHONE 277-8231

#### SEND MAIL ORDERS TO MILWAUKEE STORE

To: Amateur Electronic Supply  
3832 W. Lisbon Ave., Milwaukee 8, Wisconsin

Ship me a \_\_\_\_\_ on channel \_\_\_\_\_ (1 Free).  
Please install Extra Channels for \_\_\_\_\_ (\$5.95 per channel).  
I Enclose \$\_\_\_\_\_. I will pay balance (if any)  
in:  C.O.D.  1 Year  2 Years  3 Years  
For:  110 VAC & 12 VDC  110 VAC & 6 VDC  
See page 40 for credit information.

I want to buy a \_\_\_\_\_ and want to trade  
a \_\_\_\_\_ which was originally purchased in:

Kit form  Wired

In this form this unit originally sold new for

\$\_\_\_\_\_. I purchased it  New  Used.

Name \_\_\_\_\_ Call \_\_\_\_\_

Address \_\_\_\_\_

City \_\_\_\_\_ Zone \_\_\_\_\_ State \_\_\_\_\_

Send FREE listing of used CB & Ham gear.



tively using ring-type soldering lugs. A bakelite spacer can be made for the very end of the bottom element; it will keep the transmission line reasonably well centered within the bottom element.

### TWO-ELEMENT BEAM

The basic coaxial construction can be elaborated upon to form a two-element vertical antenna as shown in Fig. 4. Additional parts required are an aluminum conduit T-junction, an aluminum L, and the additional lengths of one-half inch aluminum conduit needed for the director element and the cross piece.

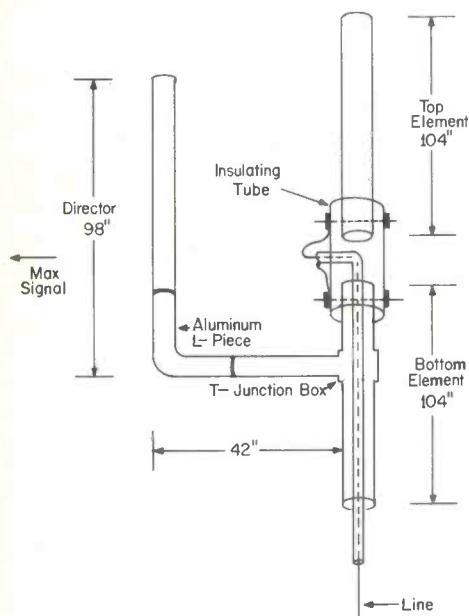

Fig. 4—Simple Two-Element Beam

The director is cut shorter than the quarter-wavelength driven element; the direction of maximum radiation is as indicated in Fig. 4. The T-junction becomes a part of the lower radiator and provides a place for attachment of the cross piece that runs out to the director. Use the dimensions shown in the illustration.

Electrical clamps can be used to mount the antenna. If the clamp bolts are not pulled up tight, the antenna can be rotated from the bottom. An additional electrical clamp attached to the vertical element only and fastened directly above one of the

mounting clamps will prevent the antenna from slipping down even though the mounting clamps are not pulled up tightly. The bottom mounting clamp can often be positioned at a location where it can be loosened and tightened whenever the antenna is rotated to a different position.

### FEEDBACK

Baxter Lay, 6Q2570, of Chadsworth, Georgia has sent in a query about the height of the V antenna discussed in November's column. According to FCC regulation the overall height may be no greater than twenty feet. The antenna works out well even at lower heights, particularly when you are lucky enough to have a high location.

R. N. Shore, KGH2975, of Burden, Kansas mentions the possibility of extending coverage up to 70 miles using even longer V-antennas longer than about eight wavelengths are not practical in CB service because of orientation problems and diminishing returns. It reduces to a line-of-sight problem. It is true that tropospheric bending does permit the wave to propagate well beyond line of sight. However, seventy miles on a consistent basis is just too much range for permitted CB antenna heights. Forty to fifty miles is really stretching out well.

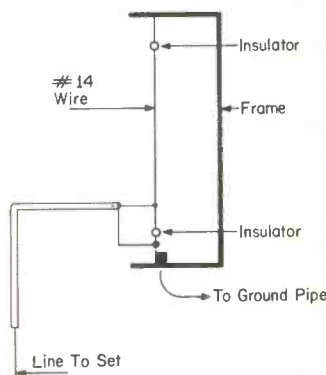
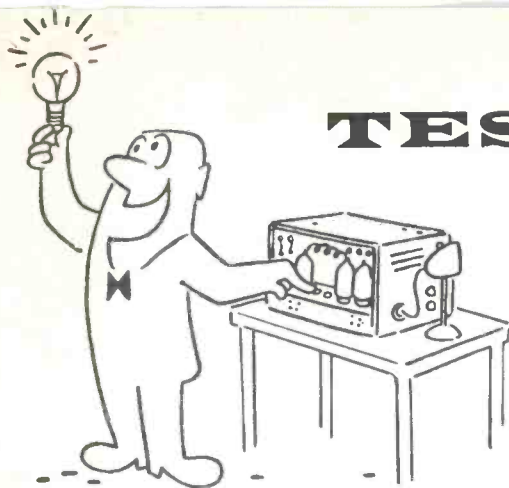

Fig. 5—Frame-Supported Antenna-Wire Vertical

F. M. Castaldi, KCC0676, of Philadelphia has dropped me a line to ask some elaboration on the dimensions of the half-wavelength antenna described in the October column. This antenna was planned for

*Continued on page 60*



# TEST GEAR

by **HERB FRIEDMAN, 2W6045**  
 2271 KNAPP STREET  
 BROOKLYN 29, N. Y.

The piece of test gear most often forgotten in any list of equipment for the CB'er is a Battery Eliminator (Charger). For those of you who may not know a Battery Eliminator is more than just a device which replaces a battery, permitting you to test mobile equipment on the test bench. A Battery Eliminator is also an easy to use and measure source of variable input voltage. By varying the input voltage the filament and B + voltages can be increased and decreased about the normal.

Fig. 1 shows a typical eliminator circuit, the PACO B-10. When S2 is in the 6 volt position adjustment of T1's rotor varies the output voltage from 0-10 volts. When S2 is set to 12 volts the output varies from 0-20 volts. Output is available from the "standard" output jacks at 12v/12 amperes or 6v/20 amperes. This current range is more than sufficient to operate a CB rig, car radio, and to *fully slow charge* (the best way) a car battery overnight. For use with transistor radios and transistor CB rigs a filtered output with a maximum rating of 5 amperes is available. Notice that both the output current and voltage is continuously monitored by meters. (You'll see the value of the meters later.)

The B-10 is available as a kit which should be easy to build, even for the novice at elec-



tronic construction. Construction time is less than three hours. Most of the time is spent in mounting the components and reading the instructions. The actual number of wires to be connected is about 20—not a difficult job. Most components mount on the front panel or on a subassembly. Notice from the photograph that even the rectifiers, which may appear difficult to handle because of their size, are easily assembled as a subassembly.

A word of caution about the wiring. The pictorials (particularly Fig. 8) shows nice "square" leads. Unless you have previous construction experience don't try for neatness. The leads are heavy bus-bar and connection

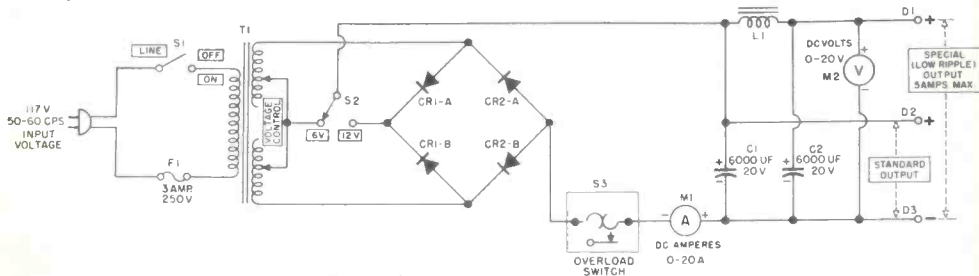

Fig. 1. Model B-10 schematic

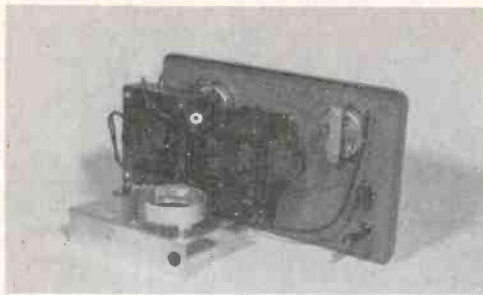

Fig. 2. The B-10 with most components mounted. Filter subassembly is on small chassis

can get difficult if you try to bend each corner square. Just orient the wires in the easiest manner; the eliminator will work just as good with rounded wiring as with square.

For a little practice in its use connect the eliminator to your mobile rig and run through a few tests. These are the same tests you would use if you were troubleshooting the rig.

Start from zero and increase the eliminators output. At 5.2 volts the vibrator should start. If the vibrator requires between 5.3 and 5.6 volts for starting its condition is ques-

tionable and it should be replaced (or it will probably break down in the middle of a transmission). If it takes 5.6 volts to start get rid of it immediately. (For 12 volts double the figures.)

Next, run up the voltage to 7.8 volts, this will considerably raise the operating voltages. If you have any weak tubes or components they are most likely to fail under the test. Better to find the breakdowns now that then when you're stuck on the road with a non-operative transceiver. This overvoltage test is one of the quickest methods for locating intermittents. A component which may cause occasional trouble is quite likely to completely fail under high voltage tests. Since most base rigs also use mobile supplies these tests can be made on base equipment.

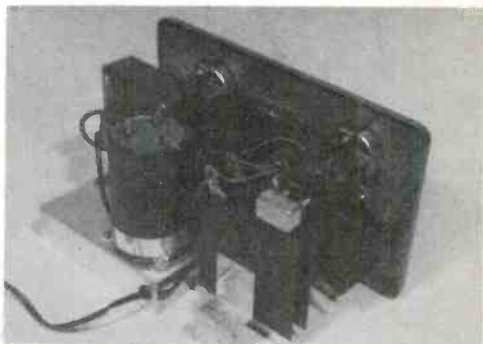

Fig. 3. The completed battery eliminator. Complete rectifier subassembly including mounting foot is mounted as a single unit. Small box on top of rectifier is overload switch which protects the transformer and rectifiers

Low and high voltage tests can also quickly help determine the cause of sticking change-over relays and intermittent squelch circuits.

By checking the current drawn by the transceiver against the original specs you can get an insight into some breakdowns which are brewing. Suppose that at 6.3 volts your rig should draw 7 amperes, but it's drawing 10. Obviously something is wrong. While 10 amperes may not be high enough to blow the fuse a steady 3 ampere overload is indicative of something about to breakdown. A simple repair made early can save a major headache.

Without too much effort, for mobile equipment, a Battery Eliminator can not only simplify servicing it can insure continuing high performance.

**FREE**

**CITIZENS BAND**  
2 Way radios and You...

**WITH ANY GLOBE C-B TRANSCEIVER!**

The complete CB story . . . what you can and can't do . . . installation information, noise control, general info for base or mobile . . . even boats. How to tune your gear. Charts, graphs and over 75 illustrations. Operating and maintenance suggestions, a CB Lingo dictionary. It's all here and it's compiled by experts . . . yours when you buy Globe.

**ADDITIONAL COPIES 100**

Special limited offer. Regular 2.00 value now only 1.00. Send cash or Money order to Globe, 400 So. Wyman St., Rockford, Illinois, USA

Send me \_\_\_\_\_ copies of your C-B information book. I enclose 1.00 for each copy.

Name \_\_\_\_\_  
Address \_\_\_\_\_  
City \_\_\_\_\_ State \_\_\_\_\_



**GC ELECTRONICS CO.** DIVISION OF TEXTRON ELECTRONICS, INC.  
ROCKFORD, ILL., U.S.A.



# CB CASEBOOK

by **LEE AURICK, 2W2870**

MT. PLEASANT RD. RFD 1  
COLUMBIA, PA.

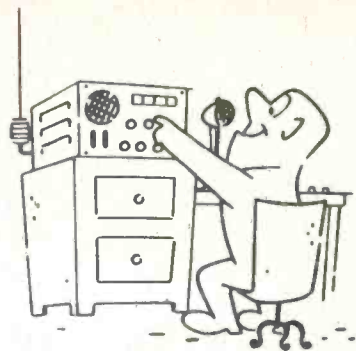

Somewhat different than any application of CB radio reported here to date is the use that the J. E. Baker Co., Millersville, Ohio, and York, Pa. is making of the many units they operate.

Operating in several states, with their quarry in Ohio, and sales offices in Pennsylvania, communications are a vital aspect of this far ranging business.

Your S9 reporter spent an interesting afternoon with Mr. Don Baker, one of the principals, who speaks with a strong affection for the service that CB performs for his company.

"We quarry limestone, and other rocks that ultimately wind-up as road stone, and railroad ballast. It's a demanding job, and one that requires 'round-the-clock attention to details, and the utmost in mechanical reliability from the equipment we use. In our quarrying operation, the superintendent is usually in sight of the work as it progresses all around him. This man is a specialist and his time is extremely valuable to us. Communication between him and the other people working in the quarry was always a problem. Since the advent of CB radio, this man is virtually two men. A radio in his car, and 'walkie-talkie' units for him and his Assistant Superintendent have just about doubled the ground he can cover in a day.

"In addition to the Superintend-

ent's car, we operate other units in the office base station, the quarry site, two road trucks, a payloader, and a bulldozer. We also have a third "walkie-talkie" in reserve, just in case it's needed.

"In Ohio we operate as KHG6544 on channel 15, and in Pennsylvania our call is 3Q1204, and all operation is on channel 22. Six company cars and a base station comprise the Pennsylvania operation, where our sales force makes just as much use of CB radio.

"Though the primary reason for our use of CB is to expedite our business, and it has proved a real time saver, it has provided all of us with the extra convenience and safety that only radio offers. Our garage mechanic has some particularly fond words for the service that CB radio means to him. In radio contact with all our vehicles, he is able to provide faster service and return them to operational status at considerable savings in time and money.

"On one occasion, I burned out a motor on the by-pass. A call to another CB station brought the mechanic and the tow-truck in a few minutes, and saved me a long trek and a wasted afternoon.

"I know that we saved money in the first month of using our radio units to pay for all of them, and every time we buy a new vehicle, the first



carries a whisper  
 . . . yet cuts out  
 background noise



the exciting new  
**Hot Head**

The new Hot Head is the highest output ceramic microphone available. Transmits voice sharply and clearly in the noisiest areas where other microphones fail. Average level: -48 DB, twice the output of conventional ceramic mikes. Response: 300-4000 cps. Polar Pattern, differential to 600 cps; cardioid, 600-4000 cps. Covers a host of applications: CB, Ham, Radio, Marine and Commercial. Heavy duty, DPDT push-to-talk switch can be re-wired for special applications. Has Cyclolac, hi-Impact, take-apart case. With nickel-plated brass hardware, 3-conductor neoprene coil cord and spring hang-up clip. **Model C47D Hot Head** List Price **\$16.00**

**EUPHONICS C47  
 MICROPHONE**

A new general-purpose ceramic mike, same as the C47D except for noise-cancelling feature. Polar Pattern, essentially non-directional. Provides high level response curve for maximum intelligibility in all voice communication.

**Model C47  
 Hot Head**

List Price  
**\$14.00**

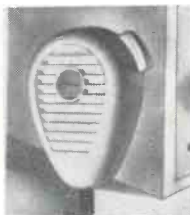

ALL AMERICAN  
 MADE

See your distributor  
 for complete details or write

**Euphonics** CORPORATION  
 Dept. S-9,  
 GUAYNABO, PUERTO RICO, U.S.A.

thing that goes in is the radio.

"We make a point of cooperating with other stations who may be using the same frequency that we are, and by company order, we have limited the time for all transmission as a courtesy to others. In Pennsylvania, we have a reliable range of ten miles, and in Ohio, where the terrain is very flat, our range is approximately twenty miles—and all units are operated at reduced power so as not to interfere beyond the distance we require for communication.

Your reporter inquired as to the problems encountered in mounting radios on such unlikely vehicles as bulldozers and payloaders.

"Once we licked the problems of vibration, and this was done through trial and error, we had no further trouble. Actually, these vehicles give us the least trouble since they have deisel engines and therefore pose no ignition problems at all. We found that the Sprauge spark suppressor kits work very well on the rest of our company cars. Each of our mobile installations use the fiber glass-type, continuous loaded whip.

"Our 'walkie-talkie' units are used wherever we can't take a vehicle in the quarry. We use them whenever we are erecting a new building, and especially when we are 'cleaning' the quarry. This is a big house-straightening job, and in addition to providing an additional safety measure, helps us to accomplish the job in a fraction of the time it once took.

"Though we use our CB radios strictly for business, all of our people are instructed to extend every courtesy to others on the frequency. We've never turned down a call for assistance from anyone, and if you're in range, we'll try to be as helpful as we can. For our part, CB is too valuable for us to treat it any other way."

**\$9**



# ELECTRONICS 'N STUFF

by **DON STONER, 11W1507**  
BOX 7388  
ALTA LOMA, CALIF.

Sam Seebee could hardly believe his eyes as he peered out of the plane window as it taxied slowly across the runway. The countryside was a beautiful lush green, and quite unlike the forced waterfired scorched earth of California, which Sam had left behind a few short hours ago. This was, of all places, Guatemala City, in the heart of Central America. As Sam sauntered down the plane stairs at La Auroa Air Terminal, his legs reminded him that the plane ride was not that short. Mentally, he noted that the next trip would be in the first class section where he could unwind his six-foot-two-inch frame.

Reflecting, Sam wondered how it happened that he was visiting this strange and exciting country. One of the big CB manufacturers was having considerable trouble with their units in this part of the world. Sam had acquired quite a reputation as a "crackerjack" repairman and the company had hired his services as a consultant and representative.

"Señor Samuel Seebee, Aeroes de Pan American, por favor" from the P.A. system, suddenly closed Sam's mental notebook. "Señor Samuel Seebee to Pan American Airlines, please," repeated the seductive voice again in English. After customs investigation, Sam lugged his test equipment laden suitcases to the Pan-Am counter. When he reached the counter, a dark good-looking gentleman extended his hand. "Señor Seebee, I am Manuel Gomez, the representative for Guatemala. We are certainly happy that you have arrived." Sam's handshake grip brought a noticeable wince from Señor Gomez. "It's a real pleasure to be here," Sam replied in fluent Spanish, much to the delight of his new friend. After checking into the hotel and cleaning up, Sam and Señor Gomez made their first service call.

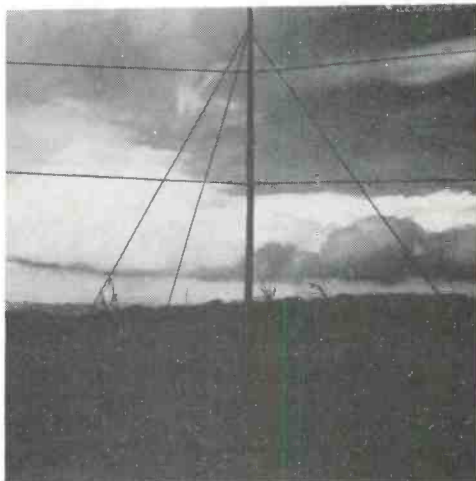

CB Antenna a la Guatemala City!

"These client ees very important man. The units we have installed do not get so much range and they sound, how you say, 'mushy.' He is one unhappy hombre." Señor Gomez filled Sam in on the details.

The rig looked like one of the latest models and Sam proceeded immediately to connect his lamp dummy load. Depressing the button produced a brilliant emission of light from the bulbs. Whistling into the mike resulted in noticeable upward modulation. "Hum," Sam wondered silently to himself. "Maybe I came 3,000 miles for nothing. Well, I hope the girls are pretty!"

Sam disconnected the load and then noticed something for the first time. "Where's the other antenna wire, Señor Gomez?" "Como?" his host replied. "There are supposed to be two wires in the transmission line to the antenna," Sam continued. Following the wire from behind the set out the window, Sam went outside. He stared in

disbelief at what he saw. "Why, it's a Windom, I haven't seen one of those in years," Sam said in amazement. "Si, señor, our servicemen only install Windom dipoles. He says they work best." Sam chuckled mentally so as not to offend his new amigo. "I think I have the answer to your problem," Sam said, reaching into his tool box for a roll of RG-58/U. A few minutes later, Sam had trimmed the 90 foot wire down to a resonant dipole only 17 feet long. "There," he said with a twinkle, "let's try that." Señor Gomez said something into the mike and someone answered something back from the speaker. Whatever was said, it caused Señor Gomez's face to flash a smile. "The mobile units report it loud and clear," he translated for Sam. "Okay," said Sam with a pleased look, "that's number one, what's next?"

Señor Gomez glanced at his watch. "Yes, we are in time. I have another installation that quits working each day about three o'clock in the afternoon and is unusable until after dinner." Sam ran his tongue around the inside of his cheek in mild disbelief. "This I've got to see, a rig that conks out on

schedule," said Sam, as they climbed into the Willy's Jeepster.

After a harrowing ride through narrow twisting streets, they wound up in front of the local Fiat automobile dealer's office. Proudly perched up on the roof was a shiny new commercial CB antenna. "At least we won't have any antenna problems here," he thought to himself. He couldn't have been more wrong! The unit was off, for, as the office manager pointed out, it was four o'clock and the transceiver wouldn't work now. As the tubes started to warm up, Sam heard a ghastly noise coming from the speaker. Heterodynes, thousands of them! Sam heard, "This is KBG4303 calling unit," blotted out by "3W44." "Hello Charlie, you're coming in better no—" This time Sam couldn't believe his ears. Here he was in Guatemala City and the States were skipping in the same as in Cucamonga. With a gleam in his eyes, he picked up the mike. "Hello test, hello test, this is 11W1507/portable testing on channel 9. Test clear." No sooner had he released the button when the unit shouted back. "Hello test yourself, this is 2W0014 in Brooklyn." Sam declined to reply. The poor slob wouldn't have believed him anyway!

Through his interpreter, Sam explained the situation. The only cure was a directional antenna system such as a beam. Fortunately, only two stations were involved and the States were at right angles to the signal path.

After a few more similar "troubleshooting" jobs, in the following days, Sam decided that all the units were working properly and the only problem was supplying more information in the instruction manual—and in Spanish.

During a period of meditation on the way home to California, Sam recapped the results of his trip to himself. For optimum results, the correct antenna system must always be used. Each installation presents a different problem. "Boy," he mused, "I sure would like to have the antenna concession down there."

**for BEST CB Performance**  
**USE GLOBE**  
**QUALITY**  
**CRYSTALS**



**INCREASES OUTPUT**  
**IN MANY UNITS**



Citizens Band Transmitter performance is no better than the crystals in the set. Globe crystals are a must for Globe equipment, will improve, many times, the performance of other units. Rigid manufacturing standards allow only the finest CB Crystals. Your distributor has them for all channels . . . see him today.

FREE CATALOG of the entire Globe CB line. Send to GLOBE dept. 31, 400 So. Wyman St., Rockford, Ill. USA

Name \_\_\_\_\_  
 Address \_\_\_\_\_  
 City \_\_\_\_\_ State \_\_\_\_\_

**GC ELECTRONICS CO.** DIVISION OF TETRON ELECTRONICS, INC.  
 ROCKFORD, ILL. U.S.A.



**S9**

**FREE PAGE** 35



# CLUB NOTES

by JOHN KREJC, 2W4586

40 LANZA AVE.  
GARFIELD, N. J.

A salute to the Civic Service CB club of Tuckerton, N. J., celebrating its first birthday November 13th. The group is very active since their area borders the Jersey coast which severe storms are common. President of the group is Larry Bard, 3Q3235.

President Fred Sharp reports that the Ocean County Emergency Aid Network, "OCEAN," aided the Lakehurst, N. J., police during the Halloween season by assisting in a communications network to keep vandalism to a minimum.

The purpose of the Boll Weevil C-Band Masters club of Enterprise, Ala., is to provide a network of Citizen Band radios for use by law enforcement agents, Civil Defense and other emergency agencies. The Band Masters will maintain a 24 hour monitoring service for the benefit of travelers.

The Huntsville, Alabama, Citizens Band operators have organized CRAC, Citizens Radio Assistance club. The new club meets each first and third Tuesday night. The members monitor 9.

Members of the Maricopa County Emergency Communications Unit recently completed the advance course in First Aid from the Red Cross, to broaden their usefulness as emergency units. Keep up the good work fellows.

The West Coast Mobile Patrol has been set up in the St. Petersburg, Florida, by the local CB'ers under the direction of Douglas Kirk. This is a volunteer organization of fellow citizens which number highly among the CB'ers as well as various other walks of life. The organization is a combination of the Police, Sheriffs, and Highway Patrols, it performs the same acts as these organizations, in and during any emergency or whenever called upon to assist.

The North Alabama Citizens Band Club has gotten off of channel 9 and are now monitoring channel 1. They have organized a air-to-ground and marine rescue teams.

One of the most active CB clubs in Western Maryland is the Hagerstown unit of REACT. In little over 3 months this unit has over 21 members with new members joining every week. The facilities of the Hagerstown Unit of REACT have been offered for Civil Defense work in Washington County, Maryland. The offer of the facilities was made by James Cross, KFC0823.

There is a new type of radio club being formed in the Portland, Oregon area. Membership is open to CB'ers and Hams for the common goal of emergency radio service for the general public, Civil Defense, Oregon Air Search and Rescue, American Red Cross, State Police and Sheriff's Office.

Edmund W. Fechner, 14Q0497, Vice-President, has now officially become President of the Apple Capitol Five Watt Association, of Cashmere, Washington.

The Minnesota Monitors CB Radio Club of Minneapolis have moved from 2105 Olson Highway to 1901 Plymouth Ave., North. They are holding meetings on the second and fourth Wednesdays of the month.

The FM Communications Club of Fargo elected a new secretary-treasurer in October—Bruce Lien, 16W4272.

Recently CB enthusiasts in the Twin City area formed the Minnesota Emergency Corps. This state-wide organization voluntarily provides needed radio service during emergencies in co-operation with local law enforcement officials. The group is also available to provide communications during parades, fairs, sports events and special events.

Good luck to the new Macomb CB'ers of Macomb County, Michigan. President of new CB club is Vincent Cuker, 19W9224. Visitors are welcome at all meetings on the 2nd and 4th Wednesday of each month held in the club room of Terrace Gardens, at Crocker Blvd. and Jefferson Ave., Mount Clemens, Michigan.

The 11-4 CB club of Michigan again this year worked communications at the County Fair, in co-operation with the Sheriffs Patrol. Thanks to Tom Bryson, 19Q8336, who was in charge of all operations and supplied control unit call.

We have the honor of hearing from the Delaware Valley Citizen Band League and receiving our first newspaper from them. The club is now three years old. They have grown these years in many many ways—equipment, clubhouse, experience, in membership—in lasting camaraderie and membership associations and lately through the very successful completion of more ambitious projects.

"Dedicated To The Betterment Of CB Radio" is the motto of the South Jersey Citizens Radio Club, Inc., P.O. Box 99, Stratford, N. J.

The Tri-County Bulletin, published monthly by the members of Tri-County Emergency Communications Net, Inc., is looking for writers for their newspaper which is quite a task for four people and they are willing to do it but would appreciate some help. If anyone would be interested please contact: Robert F. Durnin, 1W7200.

We hear that the Lancaster County Citizens Band Radio club, of the 3 area held their elections this past November, and we are looking forward to seeing the results. At this time as far as we know Carl Stief, 3Q0333, is President of the unit.

A real swinging club, The Raisin Valley CB club, sends their club newspaper, "The Hetrodyne." The clubs function is to promote a effective channel 9 monitor for the club area. The Raisin Valley CB club was organized when there were relatively few CB'ers here. This, coupled with the fact that they consist of several small towns and rural areas spread out over four counties, is a big advantage in their clubs membership success. Good luck to President Gordon Schultz, 19Q6025.

The CB Rangers Emergency Squad had the chance to prove the efficiency and effectiveness of Citizens Band Radio recently when they were called into action to cooperate in the state wide man hunt of a convicted killer. The Rangers would like to thank the State Police, Bulter City and Township police and the Evans City Police for allowing them to assist them and enabling them to prove themselves.

The Greater Dallas CB club held their Third Annual Dinner Meeting recently at Wyatt's Cafeterias. Guest speaker was Mr. G. W. Howard, Engineer in charge of the F.C.C. How about that? At this meeting the club members were to vote on their CB'er of the year . . . Here we go again, the club roster will be ready to go in a few days to all club members.

The "Signal," official publication of the Fayette-Westmoreland County CB Association, "From The Heart Of The Laurel Highlands." William Hauger, 20Q0868 is president of the fine club.

Emily Vanderslice has been appointed temporary Secretary of the Twenty-One Radio Association after the resignation of Bee McGraw. The 21 RA is now 10 months old and still growing. It is composed mostly of Service Personnel so the membership is fluctuating with



transfers to and from Hawaii. Meetings are held monthly with a special meeting set aside for social activities.

The Spaceport Radio Club of Merritt Island, announced that a 24 hour monitoring station will soon be on the air. According to Doug Dykes, KDHI1971, club president, the new monitoring station will be for emergency calls only. The installation of the CB station will be made at the Melbourne office of the Florida High-Way Patrol, and will monitor Ch. 1.

Received a nice letter from the Static Pushers Citizens Band Club of Rockford, Ill., and a copy of their new club paper. If you wish a copy write; Mrs. Frank C. Nichlos, 3229 8th St., Rockford, Ill.

The Citizens Radio League (CRL) a division of Metropolitan CB Radio Association, Inc., had printed from the 11W Call Card, the Excuse Code. We like C2;—Blonde. Co-Editors of the paper are Big Bill McCauley, KHA3262 and Little Bill Jones, KHA3315. Fine job fellows.

W. A. Wilson writes of the newly organized Royal Gorge CB'ers of Colorado. With president Harold Harris the club meets the second Tuesday of each month.

"Letters, We-Get-Letters," a new column has been started in The South Jersey Citizens Radio Club, Inc., which is a reprint of any letters that they receive of particular interest.

CD calls CB, when a freight train jumped the rails in Painesville and the local police couldn't supply the manpower that was needed, CB called on the Five Watters of Ohio to aid in control of the area. Once again the Citizens Band Radio has demonstrated its readiness to help in all emergency. Recently a call was put out that a 2 year old girl was lost in the woods at Thompson Gun Club. Seventeen members of the Five Watters responded and were joined later by 5 members from the Lakeland Radio club. 300 joined the search which ended 6:00 P.M. when the girl was found safe and sound. Thanks to all who participated from the Executive Committee. President of the group is Frank Stuart, 19A8748.

Recently the Kentucky and Indiana Citizens Radio League was called by the CD to help in a polio drive. One base unit was set up by the club at the telephone office to take all calls and then relayed them to units for pick-up of people that needed a ride to the Sport-center where the polio shots were being given.

Erv Norris of the Ottawa Five Watters tells us that the club will work with the Greater Ottawa Telethon in which to help pick-up donations.

Have you seen how the "Band Spread," official monthly publication on the Tri-County Citizens Radio Association has grown in recent months? Along with their club personality of the month, construction ideas, FCC report, and just general interest, the paper should rank above the best. All members should feel honored to belong to such a organization. Hats off to Editor, Joe Miller and his staff.

Congratulations to the Maumee Valley CB News, Walter Histed, KDHI1834, President and members of the staff for a fine club paper. Their past paper was chock full of their recent CB Round-up which was a huge success. How about the Women's Page, Oatmeal Cookies, Old Fashioned Sugar Cream Pie, Struesel Coffee Cake—little fattening, but very hard to resist. . .

Also, congratulations to Frank Joseph, 2W8083, upon being appointed Governor of the Southern New York State of M.C.E.U. (Mobile Communications Emergency Units), from Governor of New Jersey, Bert Endress, 2W9623, and Vice Governor, John F. Krejc, 2W4586. Frank is also president of the Long Island Chapter of M.C.E.U. Lots of luck and keep up the great work, Frank.

Co-ordinators for the Hagerstown, Maryland Unit of REACT, Russ Rhinehart and Ken Michal accompanied by Maryland Staff Member, Jim Cross, visited the Mountaineer CB club in Cumberland, Maryland and spoke to a fine turnout of members on the points

of the REACT program. John Kastner, 4Q1390, heads this very active club. When on Route 40 east or west in the Tri-State area give a call on 9.

The Apple Valley CB'ers of Winchester, Va., headed by president, Al Nelson, 4W1730, sponsored A Special Meeting at the Lee-Jackson Banquet Room in Winchester and had as their special guest, Mr. Ivan Loucks, of the F.C.C.; who spoke on your rights and obligations under the FCC regulations for CB operation.

From the Philadelphia area comes news of a new CB club, Teen Keystone. Membership presently is at 20, but at this writing it should be doubled. Secretary-Treasurer of the new club is Bonnie Alexander.

Also, another new club in the 12th area is the Konocti CB Radio Club of Lalseport, Calif.

Well-Now — Williamstown, N. J., is the home of the Williamstown 5 watters, which is a very expanding CB club. The club is sponsored by the local Veterans of Foreign Wars. Members of the club come from three counties. Channel 9 is monitored by the club and they are trying to get fellow CB'ers in the area to help clean-up channel 19.

Visitors are cordially welcomed at their meetings and they are ever ready to assist in any emergency. President of the club is Harry Griffith, 3Q1601. How's this Carl?

The Kern County Citizens Radio Association provided two-way radio communications for the Bakersfield P.G.A. Open Golf Championship this year. The club has also assisted the Kern County Sheriff's Dept. during the recovery of a drowning victim in the Kern River Canyon. The unit is available to provide additional necessary communications for all Police, Fire and Civil Defense agencies throughout Kern County. President of the group is Joe Hartline.

Looking at the RACINE Heterodyne Club paper we see that each and every month they are going to pick a CB'er who has done something worthwhile. This month they have chosen Ken Klema, for his fine work in printing of their paper. Anyone interested write—RACINE CB Club, 1832 Ridge Drive, Racine, Wisconsin.

Flash — received a Radiogram from the Morgan County CB Radio club that their membership has hit 52. Members should be honored to receive a fine, well constructive paper through the efforts of Ronald Gill, 18QA0665, Lucy Jackson, 18B2529, editors, and Guila Jackson, 18Q7579, Bill Spalding, KHB1044, roving CB reporters.

The October, Transmitter, club paper of the CB Rangers of Butler, Pa., announced that they are now an official REACT Team. S9 and this club editor is proud to report any Ranger news as long as we receive your club paper. You can be assured of that! Thanks also from us to the CB'ers of the club who donated blood, KIC3179, KIC1744 and Ron Lumley. How-bout their club motto, "PARATI SUMUS."

The Citizens Assistance Relay League of Long Beach, California is a organization founded on two of man's highest ideals. The ideal of the man who gives of himself and his fortune for the betterment and common defense of his community, and the ideal of the good samaritan who renders aid and comfort without thought of compensation. Good luck to this great group and to president, Herb Wright, 11Q5067.

Kenneth Hahm, 13W0669 and Chester A. Mumper, KFF0889 both write us of their services rendered during the recent storm which rained havoc along the west coast. CB proved to be a vital link in communications do to many power failures. Most beneficial was the mobile CB'er. Working with the auxiliary police they patrolled the city together in cars, reporting and investigating unauthorized persons, looting, lines down, fires and other emergencies. Fine job from us to the CB'ers in the 13th area.

Governor Bert Endress, 2W9623 and Lt. Governor

*Continued on page 58*



# WASHINGTON OUTLOOK

by EDWIN FREDERICK, 2W4580

## CITIZENS BANNED?

Since the creation of the new Class D category of station, in 1958, the Citizens Radio Service has grown from slightly over 40,000 station licensees to approximately 350,000. With this tremendous and unprecedented growth it would be expected that some rule violations would occur. However, monitoring, inspections and investigations by the Commission as well as numerous letters from licensees complaining of unnecessary interference to their operations indicate that misuse of citizens radio station operating privileges is so prevalent in some areas as to threaten the continued usefulness of the service. Accordingly, in order to maintain and improve the usefulness of the Citizens Radio Service for its intended purposes, the Commission proposes to amend Part 19, Citizens Radio Service, by revising Subpart D, Station Operating Requirements, and making other substantial changes.

The most important steps proposed are:

1. Since most of the infractions have occurred during communications between stations of different licensees (as contrasted with communications between units of the same station), additional limitations would be placed on such communications but not on intra-station communications. Thus, out of the 23 frequencies now available to Class D stations, only 5 would be available for inter-station communications. Inter-station communications would be restricted, with specific exceptions for public or civic events and other special conditions, to those necessary for the efficient management of a business or household or for control of the movement of vehicles or persons. Time limitations on the permissible length of such communica-

tions are further abbreviated.

2. In order to obtain a clearer and closer relationship of responsibility between the station licensee and the operator of the equipment, each person operating citizens radio equipment would be required to have his own station license unless an exception is clearly warranted, such as for employees of the licensee or members of his immediate household. So-called unincorporated associations would no longer be made that it would not be feasible for the radio operations to be conducted under station licenses issued to the individual members.

3. Certain undesirable practices and types of communications would be prohibited as specifically as possible instead of relying on a generalized rule as to permissible or prohibited communications; e.g., transmissions concerning the "technical performance of equipment" would be specifically prohibited. Communications to "any stations that might be listening" would also be prohibited. Both these types of transmissions have been involved in the so-called "hamming" or amateur-type operation in the citizens service. General discussions of social, political or religious doctrine would be prohibited.

4. Limitations on the height of Class B, C and D station transmitting antennas would be tightened in that if such antennas are mounted on the receiving antenna of another station, including TV antennas, they may not be placed more than 20 feet above the ground or man-made structure on which the receiving antenna itself is located.

5. Some stations would be required to make frequency or antenna changes if the contemplated rule changes are adopted.

6. The rules will specify not only a maxi-

mum of 5 watts input, but also a maximum of 3.5 watts *output*.

7. They will also call for a change in the permissible transmission time with stations other than those of the same licensee. Where at present the rules call for a maximum of 5 minutes on the air with a 3 minute "break," the new rules call for 3 minutes on-the-air with a 5 minute "break."

8. The 5 channels for inter-station communication would be channels 12, 13, 14, 15 and 23.

9. Phone patches of any kind would be barred.

10. The maximum distance for a legal contact would be 150 miles.

11. Speech scramblers and special codes will not be allowed with the exception of the "10" code and other internationally recognized codes.

If you would like to file a comment with the FCC on these proposed rules (whether you are for them or against them) you must send an original and 14 exact copies to the FCC in Washington, D.C. to arrive before January 15th. If you oppose any of the proposed changes please state all reasons for each thing opposed. If there are

things proposed which you do not want to see on CB, please be sure that you write to the FCC regarding them. Be certain to mention that you are referring to the information contained in FCC Docket No. 14843 of November 16th.

These proposed rule changes would *not* affect operations of stations using Part 15 of the Commission's rules as described in the December issue of S9. As you recall, hobby use is permitted by operation under Part 15 rules.

S9

## FINKS UNLIMITED

*Continued from page 7*

As a matter of fact, *some* form of self policing might not be a bad idea, however this is *not* the answer. A good deal of the time, those who receive the violation notices are bearing the brunt of someone's personal vendetta and have done nothing to actually deserve such a notice.

Let's stop this greasy kid stuff. If there needs to be monitoring, let the FCC do it, or let the FCC come up with an alternate plan. Taking the enforcement of federal regulations into our own hands without being asked is not the solution to the problem.

S9

## TUBE TESTER

*Continued from page 19*

metal box, a rubber grommet will hold the bulb just fine.

The test probes may be attached as shown in the schematic, or you can operate them from pins 2 and 7 of the octal socket.

After you have completed the construction, plug in a few tubes that you know are good. If the bulb doesn't light up, check the battery, bulb and connections.

By the way, this unit was built completely from parts which I had in the "junk box." The only expense I had was the price of a new sewing box for the XYL.

S9

## CLUB NOTES

*Continued from page 56*

John F. Krejc, 2W4586 of N. J. M.C.E.U. are working on plans with Sheriff Frank Davonpost to be released very shortly. Many members have joined the Sheriff's Association to date and many more are needed to make this a successful merger.

The North Jersey Chapter of M.C.E.U. will be used by the Passaic County Sheriff's Dept. in emergency's and whenever, wherever and however the Sheriff, Frank Davonport decides. January, the North Jersey Chapter will begin a crash membership drive to get the cream-of-the-crop CB'ers in the area.

From Ray Williams, KJB0035, president of the



"Yes, I'm the only 5 watt walkie-talkie in this area."



Alaska 49'ers CB Association comes the news that the club played a vital roll in the search for a lost hunter. The story is—The late Mr. Yark, the hunter, was missing for over a week and all search and rescue teams had given up hope of ever finding him. The Chugach Range Riders, (a Horsemans club) then entered the search and called upon the Alaska 49'ers for communications assistance. Without this vital link it would have been days before the hunter was found. This was a combined effort of not one organization but two and without the communication equipment supplied by Clyde Bloker, KJB0231, Fred Propper, 18W6513, Cliff Anderson, KJB0022, Ken Asplund, KJB0092 and Ray Williams, KJB0035 this case could have been delayed by several days. JOB WELL DONE. Now that the ice has been broken in the 23rd area, let's hear more . . .

Thanks to Dick Shea, KEG3726, on his very nice comment on S9. We know it is the GREATEST. Oh yes, Dick is the Vice President of the West Texas CB club, El Paso, Texas which monitors channel 11.

The welcome mat is out to any CB'ers in the Euclid, Ohio area from the Lakeland Radio club to visit any of their club meetings at any time they desire. Whether you are a member or not. As they say—"Every CB'er should belong to a club." Jim Kirk, (what happened to the call, John) is president. Hi—Jim. Keep us on your mailing list, 19Q7327.

We, of S9 wish to express our delight in helping the "Bux-Mont Radio League" 1st Annual Banquet to be a success. Hat's off to Mrs. Ed Ziter for her untiring efforts in making the banners for their mobile communications committee which ear-marks the clubs participation in various emergency and parade activities throughout the area. The 1st Annual Banquet of the Bux-Mont Citizens Radio League is over, but its memory will truly live forever in the hearts of all who attended as one of the finest events of the year.

The LYCO CB NEWS informs us that the club is interested in taking a First Aid course. The club is trying to keep channel 4 clear for emergency traffic in their area since the existence of their emergency squad. Let's all try to help them, maybe you would need this someday!

The Citizens Radio Association of Lake County, Waukegan, Ill., has been requested by the Highland Park Hospital regarding the transportation of whole blood by their mobile units in case of emergency. There are times when County Police squads are not immediately available and when whole blood is needed from some other hospital at once. Word has been sent to the hospital that the club and its members will gladly be of service.

The Memphis Radio Citizens Band Radio club monthly news publication is written and edited by Maury (6W3130) Spiro. Flash—Flash—6Q5593—is the proud father of a baby boy—Well here comes another CB'er, Best from us to all.

From Council Bluffs, Iowa and Omaha, Nebraska comes news of a new CB Radio club being formed. Meetings are held on the 3rd Friday of each month at Roberts Park, 25th and I, Council Bluffs. Anyone interested in joining the club should contact—President Dean Congdon, 113 Sioux, Council Bluffs, Iowa. The club monitors channel 14, 19 and 11.

The Metropolitan Dade Citizens Radio club of Miami Shores, Florida has elected a 12 man board to coordinate any emergency traffic that CB Radio might be able to help with. The club received a letter from Mr. A. G. Gilbert, FCC Eng. in Charge, Florida, stating—"This letter is intended to express the appreciation of this office and my personal appreciation to you and the Metropolitan Dade Citizens Radio Club for your efforts to effect a better utilization of the Class D Citizens Radio Service."

A new Citizens Band Radio Club has been organized in the Cumberland, Maryland area. The club calls itself the "Queen City 5 Watters."

**Send in items for this column!**

Write to our advertisers for special product news

## PART 15

*Continued from page 28*

noted that they were at least 20 miles distant—not bad!

NORTHERN 13, S9's Editor, Tom Kneitel, has been heard several times on Channels A and D working NORTHERN 15 and NORTHERN 16—each about 5 miles out. We haven't worked T.K. on "phone" yet but did hook him once on Channel B with CW—a 26 mile solid contact.

Several Part 15 users have asked that inasmuch as hobbying is allowed in this "no license" service, would we issue any kinds of awards for working DX and for contacting any specified number of Part 15 stations. We are therefore making arrangements for several awards along these lines, the tentative requirements are as follows:

DX award—5 "skip" contacts

Operators award—25 local contacts

CW award—10 CW contacts

QSL cards would be required as proof of the contacts. Part 19 stations, naturally, would *not* be eligible for any of these as this type of operation is illegal under Part 19 regulations.

Regular CB'ers licensed under Part 19 5-watt rules are reminded to end any *hobby* use of standard CB channels and move to the Part 15 channels—using proper Part 15 equipment which is now readily available.

Please let us know of your Part 15 activity, and the Part 15 activity in your area. If you're looking for schedules with other Part 15 stations, send us your S9 Part 15 identifier, your channels and hours of operation. We'll run them here in future issues of S9.

**S9**

### Are tune ups torture?

Are you tired of weak, ineffective signals? Tune your rig by the most effective method available. Tune up with a Delphi Field Intensity Meter model 112.

Ultra Sensitive  
Compact  
Uses no Power



Monitors % Modulation  
only  
**\$9.95**

P.P.D. Anywhere in U.S.

50 KC thru 500MC. .02 volts R.M.S. average sensitivity. Complete with antenna and choice of rubber feet or magnetic clamp for mobile use.

Dealer Inquiries Invited

**DELPHI ELECTRONIC INSTRUMENT CORP.**

57 South Grand Ave.

Baldwin, L.I., N.Y.



## ANTENNAS

*Continued from page 48*

use with any one of the standard quarter-wavelength CB antenna elements be it a full-length whip of 102-104 inches or a helical wire-type with an approximate overall length of only 4 feet. If you wish to construct the element, you may use properly supported wires (#14 antenna wire would be ideal) or quarter inch to one-half inch aluminum tubing. Each quarter-wave section should be made about 104 inches long.

Speaking of wire antennas, L. G. MacFadden KGB0403, of Denver, Colorado took to the outdoors with the #20 hook-up wire indoor-antenna of the October column. He came up with an extended vertical (refer to the December column) using hook-up wire supported on a frame. Later he changed over to #14 antenna wire with good results.

P. A. Wandelt of Summerville, South Carolina informed me of a small adjustable antenna segment he makes available. It is inserted between your regular whip and the antenna mounting base. The overall physical length of the antenna can then be varied for optimum operation on a specific channel.



## ANSWERMAN

*Continued from page 45*

### SECTION 605 AND QSL's

**Somebody said that QSL cards on CB were not allowed. Is this true or not?**

**M. T., Skokie, Ill.**

*In a recent speech, Mr. Ivan H. Loucks of the FCC made some specific comments about QSL's. The cards themselves are not illegal, but rather the way in which they are handled. Sending a card through the mail could conceivably be in violation of Section 605 of the Communications Act. This is the so-called "secrecy of communications" provision. It is designed to protect people from having the contents of their communications disclosed to a third party. When you send an exposed QSL through the mail, it may be read by anyone. If the person to whom the*

*card is addressed objects to having such exposure, his rights are protected by the 605 law. He could turn around and claim that, via the card, you have disclosed private information to a third party (even if it's just the postman).*

*This whole thing may sound ridiculous since QSL's rarely contain the kind of information one would wish to keep secret. But, I for one, would scream if such a law were taken off the books. Let's say I used CB for some business purpose and discovered that an eavesdropper was selling names of my customers to a competitor of mine. It's reassuring to know that the U.S. Government backs up my right to secrecy under Section 605. Furthermore, if my competitor bought a CB rig and profited by hearing my transmissions he, too, could expect a C-119 to drop some paratroops in his backyard.*

*The law, however, does not put a hex on QSL cards. If you wish to play it perfectly safe, seal the card in an envelope before mailing. See the September issue of S9.*

## INPUT VS. OUTPUT

**If my rig is rated at 5 watts input, why can't I get 5 watts output?**

**L. H., Denver, Colo.**

*The problem is one of efficiency and really began back in the year 1663. A funny guy wearing lace cuffs and silk knickers constructed a huge 1-ton wheel and gave it a mighty flip. Eight weeks later it ground to a halt, proving to the Marquis of Worcester that he had not created the first perpetual motion machine. We have the same problem today—nothing at present is 100 percent efficient. It's true for the CB rig. The RF Amplifier in the transmitter is operated as a so-called Class C Amplifier, a type capable of about 70 to 80 percent efficiency. The lost power can be traced to heating of the tube elements as they conduct current. Thus, you can feed in 5 watts, but end up with an output of about 3.8 watts. Other losses occur in the output tuning circuit, transmission line and antenna. You're doing well if RF energy at the antenna is approximately 3 watts.*

*Oh yes, if you meet the character who claims he measures 4 watts at his rig's output, tell him about the Marquis' fabulous fizzle.*



# S9 6 MONTH INDEX

## VOLUME 1

### JULY TO DECEMBER, 1962

#### ANTENNAS

Antenna Indicator (Stoner)  
 Antennas & Xmsn Lines (Noll)  
 Care & Feeding of Sky Hook (Girard)  
 Electrostatic Ball (Buckwalter)  
 FCC Comment on Height (Waple)  
 5/8 Wave Vertical (Noll)  
 Lightning Protection (Hurwitz)  
 Long Feed Line (Buckwalter)  
 Long Wire V Beam (Noll)  
 Mobile Whip Theory (Stoner)  
 Portable Skyhook (Buckwalter)  
 Test Units for Antennas (Noll)  
 Understand Ant. Height (Kneitel)  
 Universal CB Dipole (Noll)  
 World's Best 75¢ GP (Staff)  
 Zing Went Spring on my Car (Hurwitz)

53 Dec.  
 43 Aug.  
 28 Aug.  
 51 Aug.  
 4 Oct.  
 42 Dec.  
 32 Aug.  
 41 Oct.  
 40 Nov.  
 53 Oct.  
 52 Aug.  
 41 Sept.  
 9 Aug.  
 44 Oct.  
 16 Aug.  
 19 Sept.

CB Success Story (Staff)  
 Come to The Fair (Staff)  
 Crystal Oscillators (Stoner)  
 Elbow Room Dept. (Kneitel)  
 Fine and Ancient Art of Soldering (Hurwitz)  
 FREE FCC Warning Sign  
 FREE Station ID Certificate  
 Hale 'N Hearty (Hale)  
 Ins and Outs CB Horse Trading (Gibson)  
 Introduction To S9 (Cowan)  
 Kookie CB Callsigns (Staff)  
 Man At The Commission (Fladsrud)  
 114 Valuable Things Free (Staff)  
 Our First Subscriber  
 Power Supply Modif. (Friedman)  
 Prehistoric CB Report (Kneitel)  
 RF Final Amplifiers (Stoner)  
 Single Sideband (Miltenberg)  
 Stop Those Citizens Bandits (Gibson)  
 13 Delightful Ways to Ru(in) A CB Convention (Kneitel)

28 Oct.  
 30 Aug.  
 55 Aug.  
 7 Sept.  
 22 Aug.  
 26 Oct.  
 27 Oct.  
 38 Nov.  
 34 Aug.  
 7 July  
 34 July  
 33 Oct.  
 9 Nov.  
 60 July  
 18 Nov.  
 30 July  
 53 Sept.  
 23 Oct.  
 22 Sept.

#### CIVIL DEFENSE

All About REACT  
 CB and Civil Air Patrol (Kneitel)  
 CB and Civil Defense (Kneitel)  
 Conelrad Drapped (Frederick)

27 Nov.  
 16 July  
 7 Aug.  
 57 Oct.

What You Should Know About RADAR Traps (Kneitel)  
 What's NU With Nuvistaplugs? (Gibson)  
 World's First CB'er (Staff)

7 Oct.  
 9 Oct.  
 15 Nov.  
 26 Aug.

#### CONSTRUCTION PROJECTS

Antenna Indicator (Stoner)  
 BCI Trapper (Staff)  
 CB DF'er (Girard)  
 Field Strength Meter (Barbee)  
 Modify Vocaline ED-27M (Lewis)  
 RF Gain Control (Hurwitz)  
 Signal Monitor (Friedman)  
 Mobilimeter (Barbee)  
 Plug-in Surgery (Gibson)  
 Preamplifier (Hurwitz)  
 Signal Snatcher (Thompson)  
 Simple Noise Limiter (Hurwitz)  
 Stop Those Citizens Bandits (Gibson)  
 SWR Bridge (Miltenberg)  
 Transistorized Mike Preamp (Hurwitz)  
 Viva La TNS (Friedman)  
 Whistlestop (Turner)

53 Dec.  
 46 Aug.  
 17 Oct.  
 13 Sept.  
 28 Sept.  
 29 Dec.  
 25 Aug.  
 20 Oct.  
 14 July  
 9 July  
 22 Dec.  
 24 Nov.  
 22 Sept.  
 22 July  
 14 Oct.  
 19 Aug.  
 21 Nov.

#### INTERFERENCE

BCI Trapper (Staff)  
 Fluorescent Buzz (Buckwalter)  
 Hi-Fi Interference (Buckwalter)  
 Image Rejection  
 Scalping TVI (Staff)  
 TVI Elimination (Buckwalter)

46 Aug.  
 40 Dec.  
 51 Aug.  
 48 Sept.  
 42 July  
 44 Nov.

#### MISCEL. TIPS

Fluorescent Buzz (Buckwalter)  
 Home Study (Buckwalter)  
 Hot Lead Connection (Buckwalter)  
 Image Rejection (Buckwalter)  
 Kick-to-Talk (Buckwalter)  
 Mobile Mounting (Buckwalter)  
 Scrambler (Buckwalter)  
 6/12 Volt Operation (Buckwalter)  
 Skip Explanation (Buckwalter)  
 Vibrator Problems (Buckwalter)  
 Voltage Dropping (Buckwalter)

40 Dec.  
 45 Nov.  
 55 Oct.  
 48 Sept.  
 55 Oct.  
 52 Aug.  
 45 Nov.  
 41 Dec.  
 44 Nov.  
 47 Sept.  
 47 Sept.

#### DEPARTMENTS

Answerman (Buckwalter) 50 July, 51 Aug., 47 Sept., 41 Oct.,  
 44 Nov., 40 Dec.  
 Antennas (Lee) 27 July  
 Antennas (Noll) 43 Aug., 41 Sept., 44 Oct., 40 Nov., 42 Dec.  
 Canadian GRS Notes (Arnovitz) 31 Sept., 42 Oct., 46 Nov.,  
 46 Dec.  
 Casebook (Aurick) 54 July, 53 Aug., 51 Sept., 51 Oct., 52  
 Nov., 51 Dec.  
 Club Notes 58 Aug., 56 Sept., 56 Oct., 56 Nov., (Krejc)  
 55 Dec.  
 Electronics 'N Stuff (Stoner) 52 July, 55 Aug., 53 Sept.,  
 53 Oct., 54 Nov., 53 Dec.  
 50 Over 9 (Kneitel) 57 July, 7 Aug., 7 Sept., 7 Oct., 7 Nov.,  
 (see KBG4303 Rides Again!)  
 KBG4302 Rides Again! (Kneitel) 7 Dec.  
 On The Counters 37 July, 37 Aug., 35 Sept., 36 Oct., 31  
 Nov., 34 Dec.  
 Reader Mail 4 July, 4 Aug., 4 Sept., 4 Oct., 4 Nov., 4 Dec.  
 Test Gear (Friedman) 46 July, 47 Aug., 45 Sept., 47 Oct.,  
 50 Nov., 47 Dec.  
 Washington Outlook (Frederick) 56 July, 59 Aug., 57 Sept.,  
 57 Oct., 57 Nov., 57 Dec.  
 YL Korner (Daly) 43 Oct., 47 Nov.

#### PART 15

11 Meter CW (Hurwitz)  
 Fiction or Fact (Stoner)  
 FREE Station Identifiers (Staff)  
 Transceiver Roundup (Staff)

26 Dec.  
 9 Dec.  
 19 Dec.  
 13 Dec.

#### POETRY

A CB'ers World (Easley)  
 A Word That Means A Lot To Me (Easley)  
 There Was A CB'er (Haymon)  
 There Was A CB'er Pt. 2 (Haymon)

18 Sept.  
 19 Oct.  
 48 Nov.  
 48 Dec.

#### PRODUCT REPORTS

ACA Power Dart  
 Advance Prod Mileage Maker  
 Allied C-11  
 Ameco Converter  
 Dick Tracy 2-Way Radio  
 Drake TVCB Filter  
 EICO 770  
 ELI Power Supply  
 GC Signal Generator  
 Heath GDO  
 International ECEC 10  
 International Clipper  
 Pearce Simpson Companion  
 Radiophone Panadaptor  
 Raytronics Nuvistaplug  
 Sampson CB Station  
 Speakeasy  
 Stoner Auto Patch

39 Sept.  
 36 Dec.  
 35 Nov.  
 41 July  
 35 Dec.  
 39 Oct.  
 40 Aug.  
 40 July  
 50 Nov.  
 47 Dec.  
 39 July  
 40 Oct.  
 38 Dec.  
 13 Aug.  
 38 Sept.  
 38 Oct.  
 38 July  
 39 Aug.

#### FEATURE ARTICLES

All About CB QSL's (Kneitel)  
 All About Modulation (Stoner)  
 All About REACT  
 CB Aids Paraplegics (Match)  
 CB and CAP (Kneitel)  
 CB Behind Bars (Aurick)  
 CB Call Area Map  
 CB Flickers  
 CB Radio Shop (Aurick)  
 CB Real Estate Sales (Aurick)  
 CB SCUBA Diving (Aurick)  
 CB Service Station (Aurick)  
 CB Slang Dictionary (Fisher)

10 Sept.  
 54 Nov.  
 27 Nov.  
 25 Sept.  
 16 July  
 52 Nov.  
 32 Nov.  
 27 Aug.  
 55 July  
 53 Aug.  
 51 Sept.  
 51 Oct.  
 15 Sept.

#### PUZZLE

CB Crossword (Owens)

30 Oct.

## Index of Advertisers

Aerospace Communications Antennas	22
Amateur Electronic Supply	28, 29, 38, 40, 47
Browning Laboratories	6
Crater Lake Antennas	45
Creative Products	24
Delphi	59
ECHO Communications	43
EICO Electronic Instr. Co. Inc.	3
e.c.i. electronics communications, inc.	42
Euphonics	52
G.C. Electronics	12, 39, 50, 54
General Radio Telephone Corp.	Cover 4
Hallicrafters	32, 33
Hy-Gain Antenna Products	64, Cover 3
International Crystal Mfg. Co.	Cover 2, 1
Knights, James Co.	63
Lafayette Radio	8
Lew Bonn	36
Multi Products	41
Part 15 Identifier	25
RCA	5
Raytronics	39
S9 Subscriptions	35
SECO	41
Shure Brothers	27
Stoner Electronics	39
Stuart Electronics	22
TRAM Electronics	27
Turner Co.	31
Utica Communications	19
World Radio Labs	21

## CB SHOP

Rates for CB SHOP are 10¢ per word for advertising which, in our opinion, is obviously of a non-commercial nature. A charge of 25¢ per word is made to all commercial advertisers or business organizations. A 5% discount is in effect for an advance insertion order for six consecutive months.

We do not bill for advertising in CB SHOP. Full remittance must accompany all orders and orders sent in otherwise will not be run or acknowledged.

Closing date is the 15th of the 2nd month preceding date of publication.

We reserve the right to reject advertising which we feel is not suitable.

Because the advertisers and equipment contained in the CB SHOP have not been investigated, the publishers of S9 cannot vouch for the merchandise or services listed therein.

**WANTED:** Experienced CB engineers for design and manufacture of transceivers for major CB manufacturer in midwest. Good pay. Submit resumé. All replies strictly confidential. Box A, S9 Magazine, 300 West 43rd St., New York 36, N. Y.

**CB REPAIRS—CALIBRATION,** reasonable prices, FCC licensed technicians. **ELECTRONIC SPECIALTIES,** Box 13, East Patchogue, N. Y. ATlantic 6-9467.

**Combination CB/Broadcast band Walkie-Talkies.** Like new. Condition guaranteed. Original pair cost \$125.00. Write for information: Ros Stovall, 3735 Marrison, Indianapolis 5, Indiana.

**CREATIVE CBL CARDS—Free,** new catalog and samples. Personal attention given. Wilkins Creative Printing, P.O. Box 1064-9, Atascadero, California.

**C. FRITZ CBL's—Rainbo calls,** state maps. Samples 25¢ (deductible). Box 1684, Stottsdale, Arizona.

**CB QSL cards.** Samples free. Paul, 7701 Tisdale, Austin, Texas.

**QSL CARDS—Three colors:** \$12 per thousand. Samples 25¢. "JERRY," 491 Prospect Street, Glen Rock, New Jersey.

**CB QSL CARDS,** 2 color, glossy, 100 for \$2.50, samples dime. Ramsbottom Printing, Box 237A, Kirksville, Missouri.

**QUALITY QSL's—New designs monthly,** Samples 10¢—Giant 25¢. Savory, 172 Roosevelt, Weymouth, Mass.

**QSL's, Regular or Special, Frier Specialties,** Harvard Street, Schenectady. Samples 25¢.

**CB-QSL's over 100 designs,** samples 10¢. Roger K0AAB, 961 Arcade, St. Paul 6, Minn.

**For Sale—One complete set of Popular Electronics Magazine.** Every issue published to date is included. \$50.00. John Cook, 3105 Mt. Vernon Bakersfield, California.



NEW for 1963 — Speech clipper-kit complete \$17.85! New Dual Conversion adapter kit in easy-do form. Hear only the channel you tune. Enjoy better selectivity, greater sensitivity. All parts, schematic, pictorial complete. HE-15, A, B; TR-800, 910, B; etc. HE-20, A, B, C; Mark VII; 770, 1, 2; Messenger; GW-10 etc. Order Now! Specify exact model. All Duals now \$15.50 ea., with tubes \$17.50, or \$5.00 deposit plus C.O.D. Free literature, Dept. "9," Bainbridge Radio Electronics, 2839 Briggs Avenue, New York 58, N. Y.

WHOLESALE! 8-T. Pocket Radio, Earphone, Case & Battery. \$6.95 Postpaid. MALINAK'S, SENECAVILLE, OHIO.

Heathkit owners! Double reception! SK-4 Preselector mounts inside GW-12. SK-3 Preselector inconspicuously mounts outside GW-10, GW-11. Either kit, \$8.99; wired, \$11.99. All postpaid. Free kit list. HOLSTROM ASSOCIATES, P.O. Box 8640-S, Sacramento 22, California.

NEW! Revolutionary Hy-Gain Omni-Topper rooftop, non-directional mobile antenna, \$11.97. DP-2 Coupler-Duplexer kit, eliminates separate BC antenna, \$4.99. AAA-1 Clipper-filter kit, modulation booster, triples talk power of any CB transceiver, \$10.99. All postpaid. HOLSTROM ASSOCIATES, P.O. Box 8640-S, Sacramento 22, California.

HUNDRED QSL's: 80¢. Samples, dime. Meisinger, Jesup, Iowa.

ELECTRONICS COURSE only \$14.95. Includes all tubes, parts, tools, instructions. Write for full information. Progressive "EDU-KITS" Inc., Dept. 501 CM, Hewlett, New York.

CB QSL CARDS—CALL LETTER D-CALS—all thick glossy cards. Many colors. Samples 25¢ (re-funded), Dick, 19QA0625/W8VXK 1996 "S" N. M-18, Gladwin, Mich.

HEATHKIT OWNERS! Double reception! SK-4 preselector mounts inside GW-12. SK-3 preselector inconspicuously mounts outside GW-10, GW-11. Either kit, \$8.99; wired \$11.99. DP-2 coupler-duplexer kit, \$4.99. Compact AAA-1 clipper-filter kit triples talk-power, improves selectivity, \$10.99. Free kit list. HOLSTROM ASSOCIATES, P.O. Box 8640, Sacramento 22, California.

"INSTANT EYE BALL". Your present Call Card becomes an Eye Ball QSL Card INSTANTLY with these pressure sensitive EYE BALL QSL LABELS. \$1.00 per 100. Samples 10¢. ERROL ENGRAVING, WESTFIELD, MASS.

CB QSL CARDS—100 two color \$3.00 postpaid, samples 10¢. Rusprint, Box 7507, Kansas City 16, Missouri.

\$10 DOWN DELIVERS your CB equipment with 12 to 24 months to pay balance. This month's specials . . . RG8/U coaxial cable only 7¢ per foot (FOB New York) . . . also, any CB transmit or receive crystal, for any type of CB transceiver . . . \$2 each. Include 25¢ additional with order for postage and handling of crystal. House of Sound, 2119 Starling Avenue, New York 62, N. Y.

STINGER—32" of Dynamic CB Antenna. Model ST-1, \$14.95. Postpaid. Bussard Company, Drawer 10, Reynoldsville, Pa.

CB, WPE, QSL Cards, Samples Free. Radio Press, Box 24S, Pittstown, N. J.

IMPROVE GW-10 PERFORMANCE! — Better transmission, reception! Reduce mobile noise! Instructions \$1.00, postpaid. FRANKEL, Box A-143, Wantagh, New York.

CB QSL cards . . . send for FREE brochure. Frank B. Mathews Printing & Advertising, 1616 Rural Street, Rockford, Illinois.

CB QSL card. Samples 10¢—MALGO PRESS, Box 375—Toledo 1, Ohio.

NEED CB QSL CARDS? 25¢ brings samples, prices and 50¢ coupon. Redbird Printers, Freedom, Indiana.

CB-QSL Cards — Brownie — W3CJI/3W1974 — 3110—D Lehigh, Allentown, Pa. Catalogue with samples 25¢.

CB—Eliminate 2nd antenna bleed-off! OZCO "1-10'er" CB-AM antenna coupler permits CB operation and broadcast reception from one CB mobile antenna, even at the same time! Compact, Guaranteed unsurpassed. Easily installed. Only \$5.95 each, postpaid. OZCO ELECTRONICS, Canaan, Connecticut.

CB, QSL, SWL Cards that are different. Quality Card Stock. Samples 10¢ Home Print, 2416 Elmo, Hamilton, Ohio.

GLOSSY 3-color QSL cards 100 — \$4.50. Free samples. Rutgers Vari-Typing Service, 7 Fairfield Road, Somerset, New Jersey.

FREE SAMPLES—CB QSL CARDS. \$2.50 per 100 in 3 colors, POSTPAID. Garth Printing Company, Box 51 S, Jutland, New Jersey.

CB QSL cards . . . samples free . . . Will also print special cards from your illustration. Fast service. BOGIN PRINTING, 2775 East 12th Street, Brooklyn 35, New York.

**JAMES KNIGHTS  
"GOLDEN LINE"  
CITIZENS BAND  
CRYSTALS**



Dealer, distributor and  
manufacturer inquiries invited

**The James Knights Company**  
Sandwich 9, Illinois



Announcing new "goodies" from **Hy-Gain**

# VERTI-POLE

**NEW MODEST-PRICED  
1/2 WAVE  
VERTICAL ANTENNA**

Now... a high performance 1/2 wave length vertical antenna at a real budget price. Engineered and proven, through exhaustive tests, to out-perform any standard ground plane antenna. Designed for easy attachment to masts with diameters up to 1 1/2 inches, the Verti-Pole features:

- Full Omni-directional pattern
- 2db gain in measured field strength intensity
- Voltage feeding through a 1/4 wave length shorted matching stub—eliminates the need for loose matching transformers and coils
- Matching device places antenna at DC ground potential...substantially lowering residual noise level in receive function resulting in actual operating gain of up to 10db
- VSWR: 1.5-1 over entire CB band
- Rugged, heavy-duty all aluminum construction with overall height of 17 ft.
- Construction that complies with F.C.C. regulations
- Irridite treated base assembly for lasting durability
- Delivery as a complete unit—including mounting clamp and hardware—ready to install

If you are looking for a real bargain in a high performance base station antenna—one that will equal or surpass the performance of other extended vertical antennas—you want a Verti-Pole at only **\$33.25** List.

**FOR GREATEST POSSIBLE RANGE...**

The  
EXCLUSIVE

# GOLDEN COLINEAR

If you want the very finest in a base station antenna, see Hy-Gain's exclusive Golden Colinear...designed to double the effective radiated power of any CB transceiver in not only one direction, but in all directions. The Golden Colinear delivers 3.4db of omni-directional gain in measured field strength intensity (the only gain measurement method that relates to both the transmit and receive functions). In receive function, the Golden Colinear will develop up to 20 db of gain through a vastly improved signal to noise ratio. The radiating element is at DC ground potential which lowers the noise level substantially by eliminating static build-ups. Ruggedly constructed to meet rigid commercial specifications, the irrudite treated Golden Colinear will survive winds of 100 MPH with 1/2 inch radial ice load. Truly the world's most outstanding CB Base Station antenna at **\$93.00** List.

# THE ALL NEW **hy-gain** OMNI-TOPPER

**THE CHOICE OF THE PROFESSIONALS**

Here's the newest member of the famous family of Hy-Gain "Toppers." The revolutionary, new Omni-Topper... specifically designed to take full advantage of every factor involved in attaining maximum efficiency from C.B. equipment. Featuring:

- Perfect omni-directional pattern.
- Efficient Hy-Gain top loading design which effectively shortens antenna while leaving current section of the antenna (which does 78% of radiating) near its full length
- Center roof mounting assures superior current distribution
- Perfect 50 ohm load allows optimum transfer of energy without the use of lossy matching devices
- Scant 29 inch overall height insures convenient motoring
- Miniature heavy-duty spring at base allows antenna to be tied down for low garaging
- Feed line attaches internally to exclusive Hy-Gain base mount - no separate connector required
- Easy installation - largest hole required is 1/4 inch - full access to outside surface

All in all, the Omni-Topper represents a major break-through in advanced design of quality Citizens Band antennas. For appearance, performance and reliability, it is truly the Professional's choice at only **\$19.95** List.



**ANOTHER HY-GAIN FIRST... UNIVERSAL**

## STATIC ARRESTOR



Scientifically designed to place any ungrounded 27 megacycle antenna at DC ground potential. Positively bleeds off static build-ups and reduces noise in the receiver by some 10 to 20 db. Offers lightning protection. Highly effective on all types of Mobile Antennas as well as all common types of Base Station Antennas such as 1/4 wave length Ground Planes, Coaxial Antennas, Split Dipole Beams, Coaxial Beams and Colinears. Exclusively Hy-Gain and only **\$2.75** List.

See the complete line of Hy-Gain mobile and base station antennas plus body mounts and accessories at your favorite C.B. supplier's or, write for full descriptive literature.

**hy-gain** ANTENNA PRODUCTS

8460 N.E. Highway 6, Lincoln, Nebraska



**5 Progressive Technical Advances  
created the**

*General MC5*



**FREE!**  
Write for  
schematic  
and complete  
technical  
manual



**The World's most advanced 11 meter two-way radio**

3.25 watts minimum output

**ONLY GENERAL MC5 HAS SIDEBAND NOW!**  
See It At Your General Dealer TODAY!



The only single precision instrument that measures True Power, Standing Wave Ratio, Relative Field Strength, Net Price \$39.95. F.O.B. Burbank, California. FREE—Write for schematic and complete technical manual.

operation. • 15 watt construction.  
Net Price including microphone and crystal... \$199.95.  
Optional accessories available. 6 Volt or 12 Volt cord, each \$4.95. Crystal T or R, each \$2.95. 90 day warranty. F.O.B. Burbank, California.

Under present rules part 19.32 the FCC does not provide for more than five (5) watt input in the Citizens Radio Service (26.965-27.225 MC Band)

*General*

Your dealer or write:

**RADIOTELEPHONE COMPANY**  
Dept. S11, 3501 Burbank Boulevard, Burbank, California

**S9** 300 West 43rd Street  
New York 36, N.Y.

Controlled Circulation Postage Paid at New York, N. Y.

POSTMASTER: SEND FORM 3579 TO: S9, 300 WEST 43rd STREET, NEW YORK 36, N. Y.